

Name: _____

Letter Review

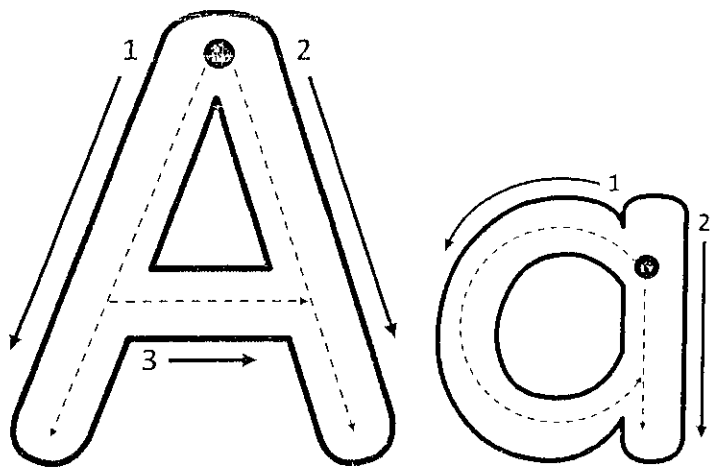

Find the letter

V	A	a	G
a	F	A	A
A	a	N	a
a	d	f	A

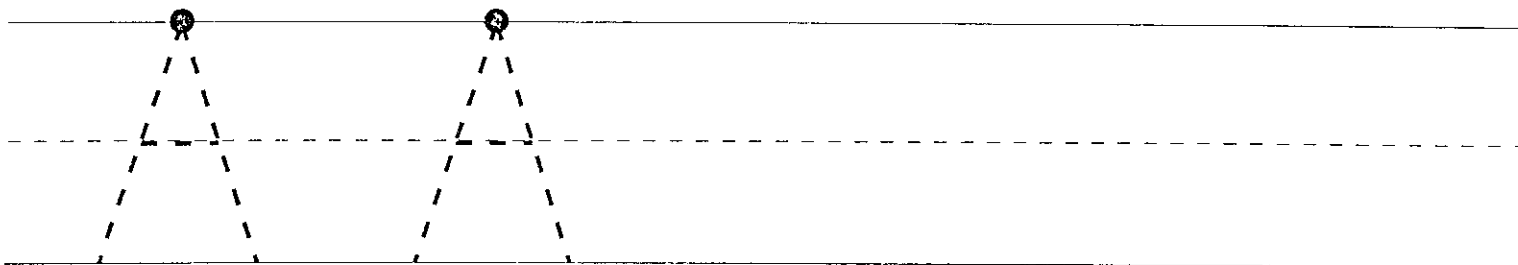

Color all the pictures with this letter sound.

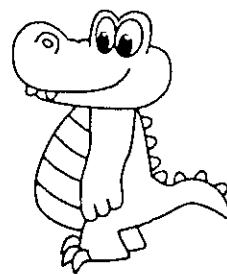
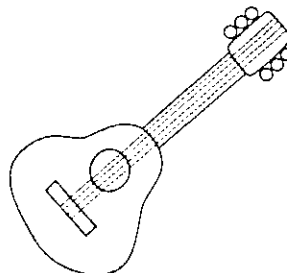
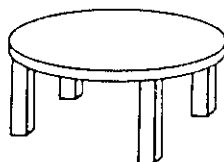
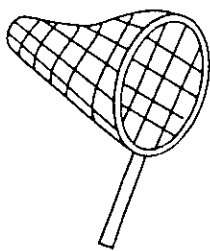
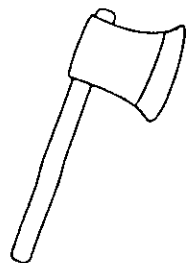
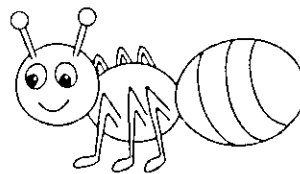
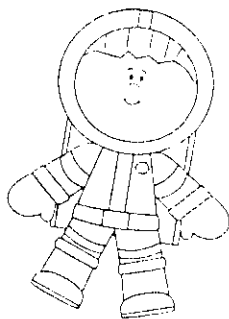
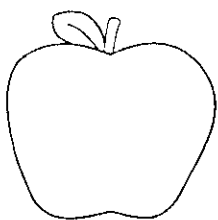
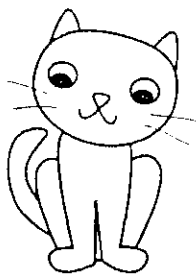

Name: _____

Letter Review

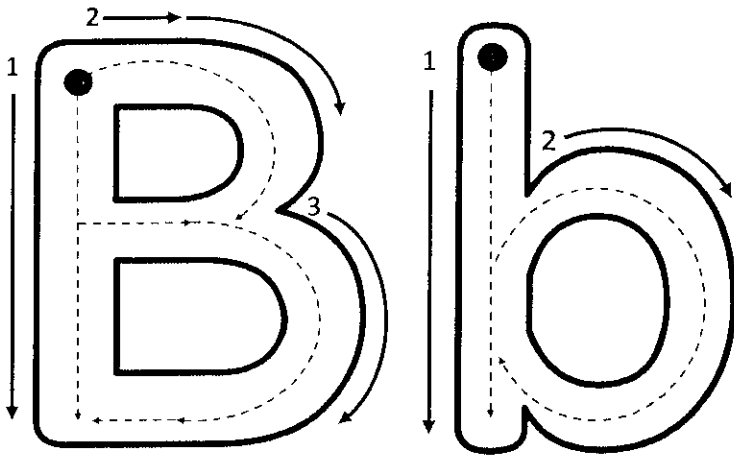

Find the letter

b	D	B	b
t	B	b	G
s	b	Q	B
B	r	B	b

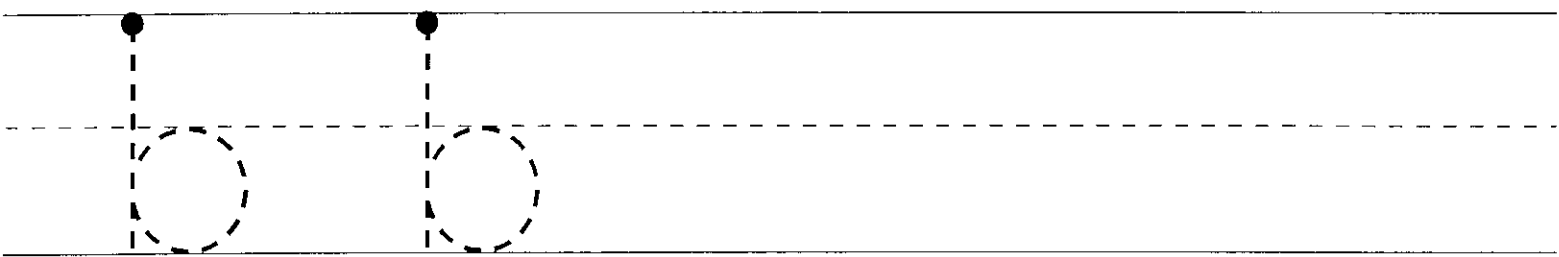
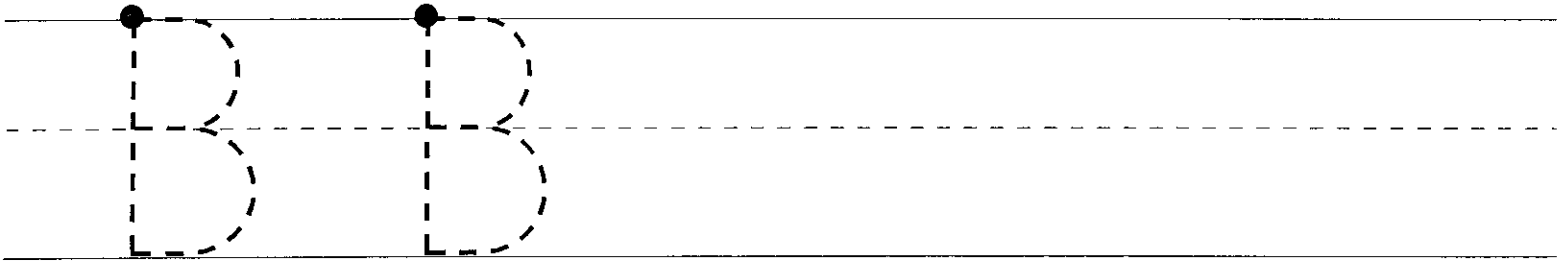

Color all the pictures with this letter sound.

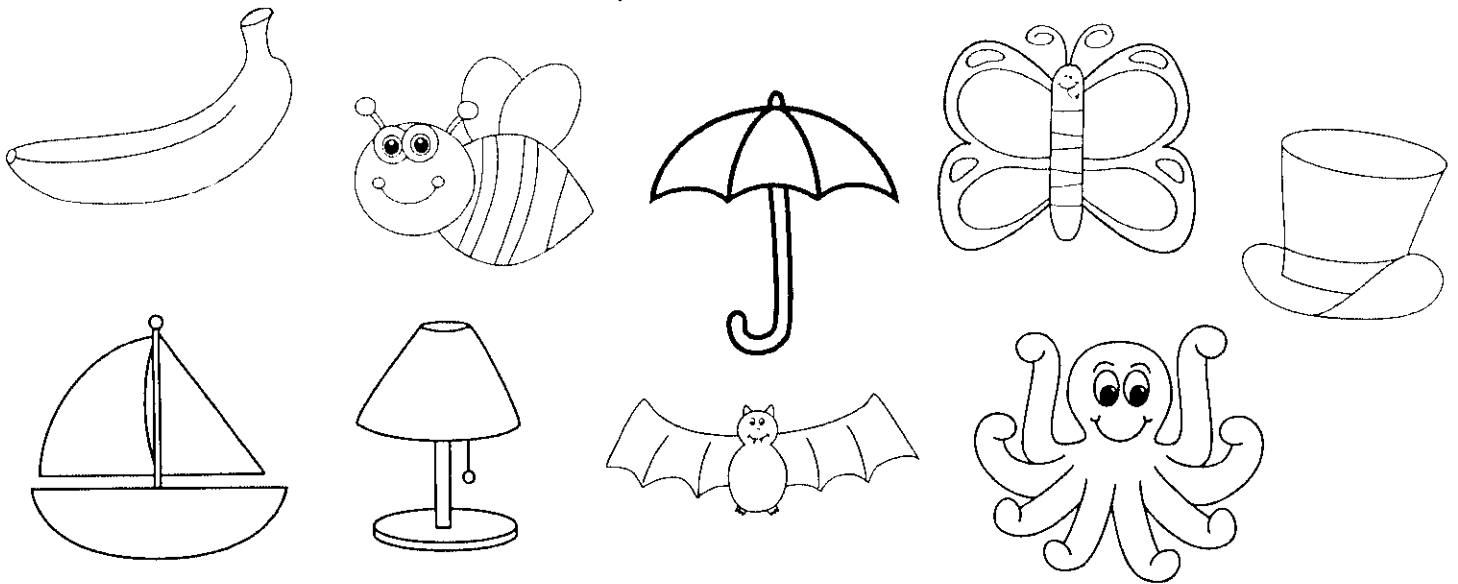

Name: _____

Letter Review

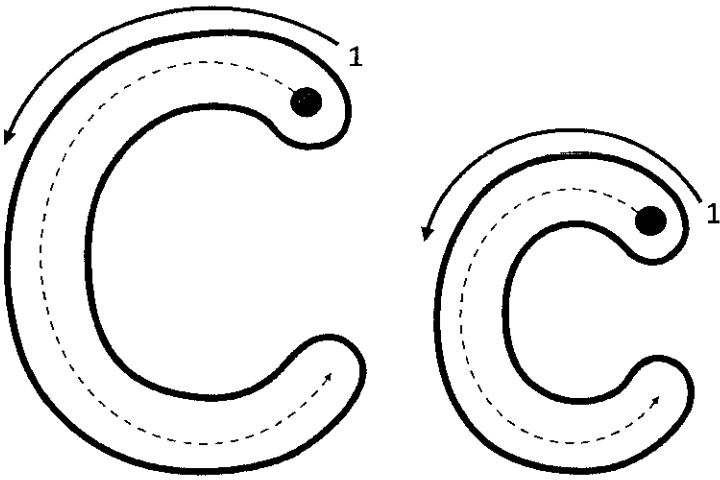

Find the letter

C	R	v	C
a	c	C	L
c	C	c	C
c	j	C	F

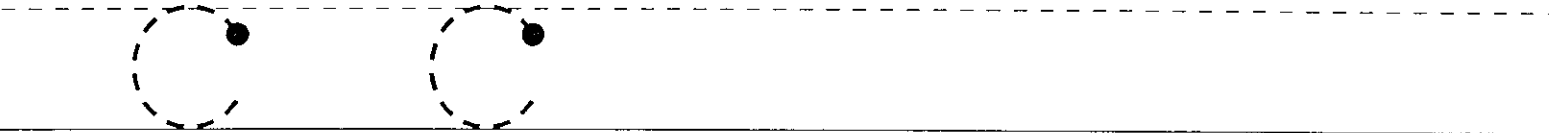
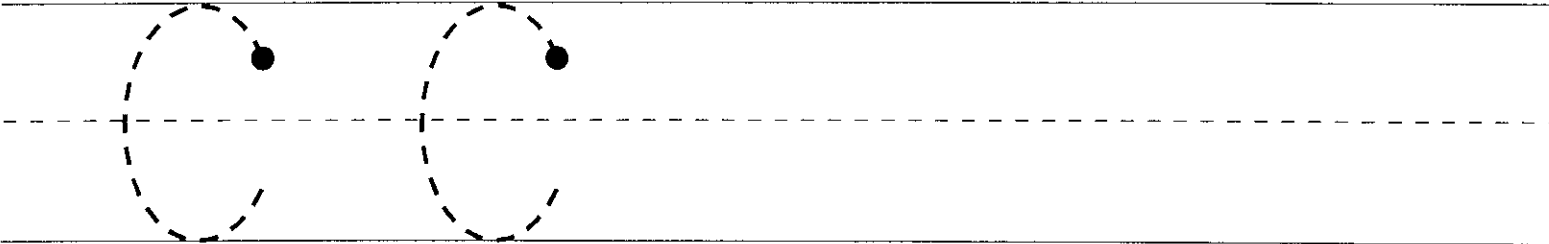

Color all the pictures with this letter sound.

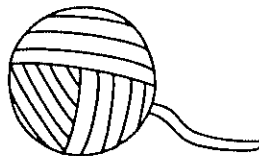
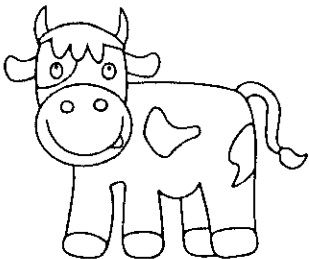
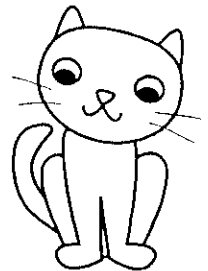
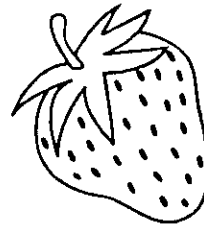
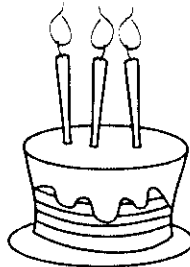
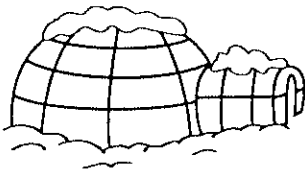
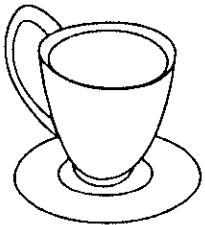

Name: _____

Letter Review

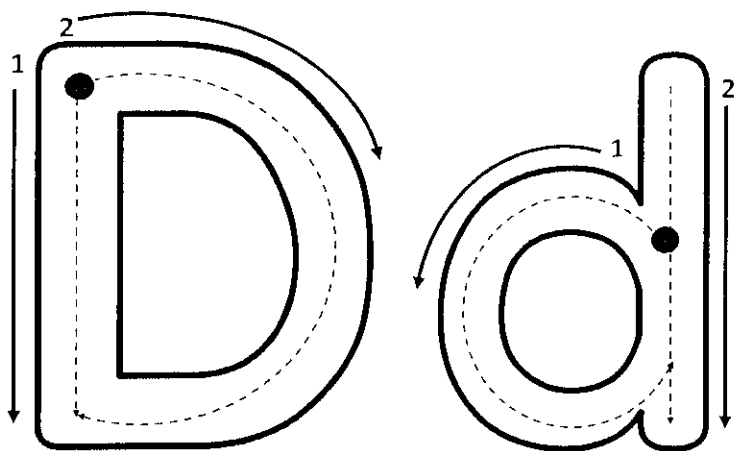

Find the letter

d	L	D	d
d	D	z	D
X	w	D	h
D	d	y	d

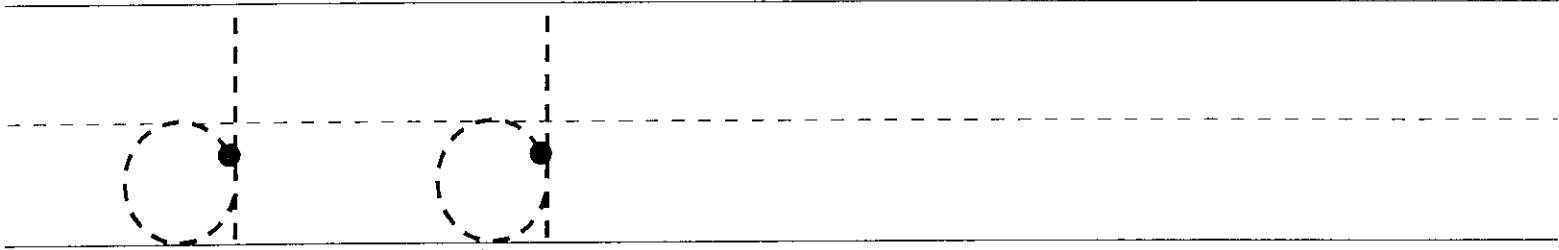
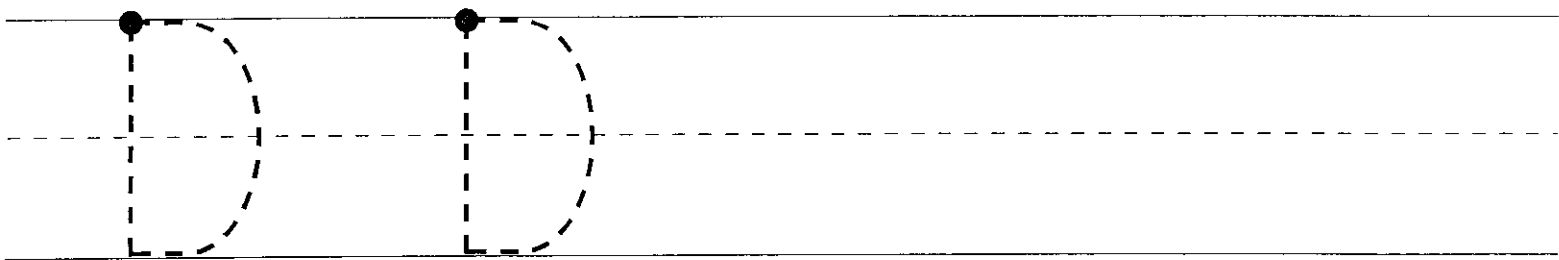

Color all the pictures with this letter sound.

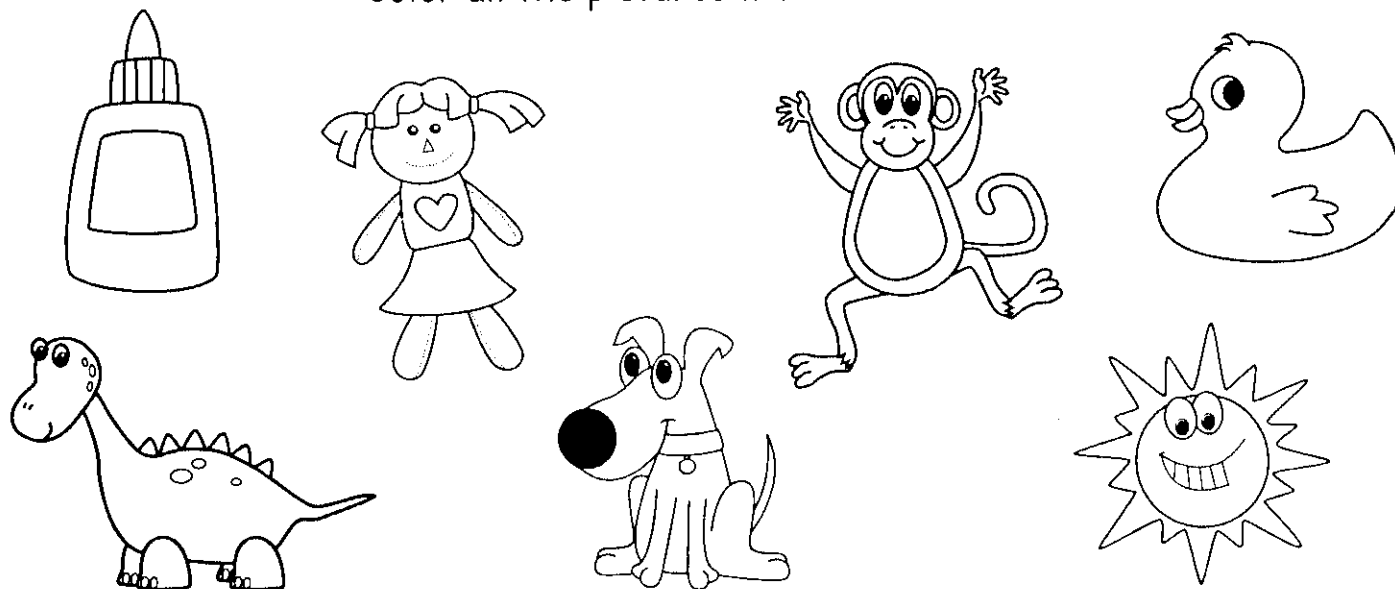

Name: _____

Letter Review

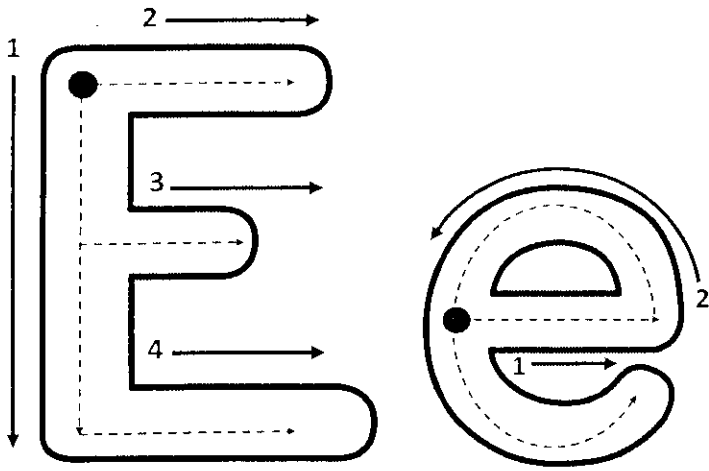

Find the letter

e	Z	E	e
S	E	e	E
E	m	E	R
e	d	g	e

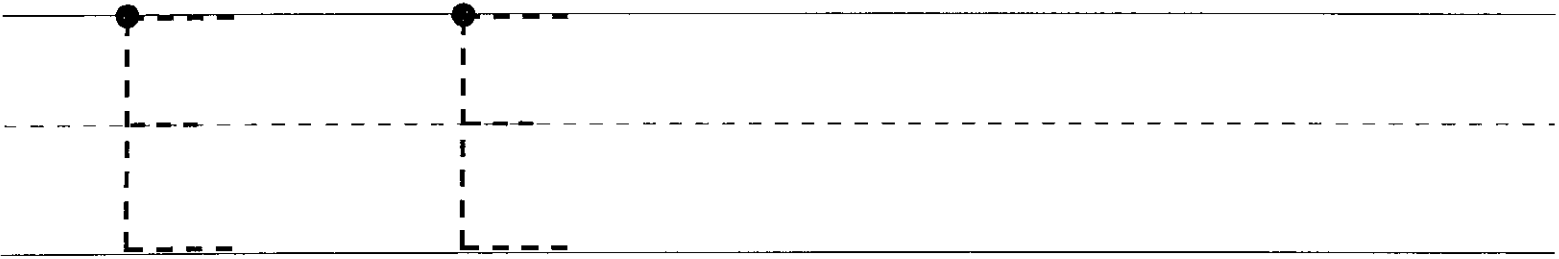

Color all the pictures with this letter sound.

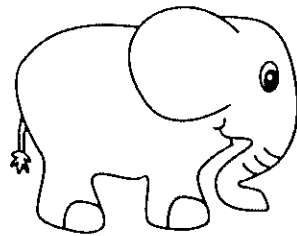
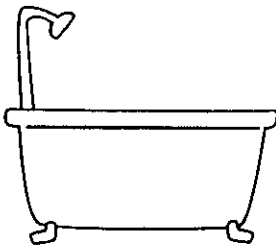
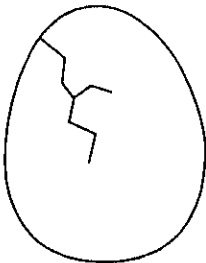
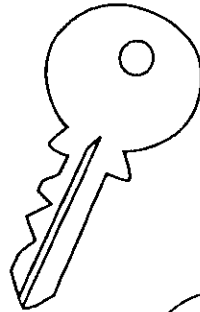
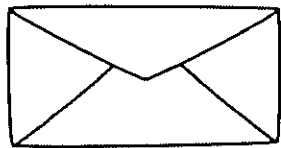
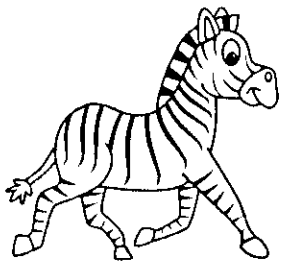

Name: _____

Letter Review

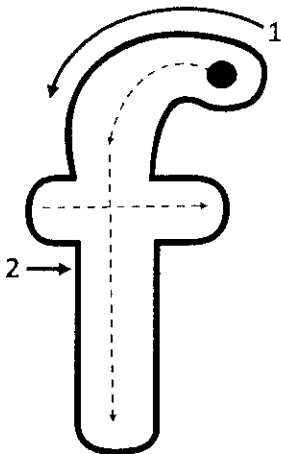
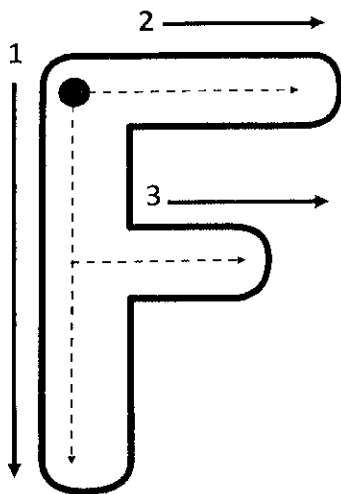

Find the letter

f	M	f	F
h	F	f	A
F	k	F	f
S	F	f	V

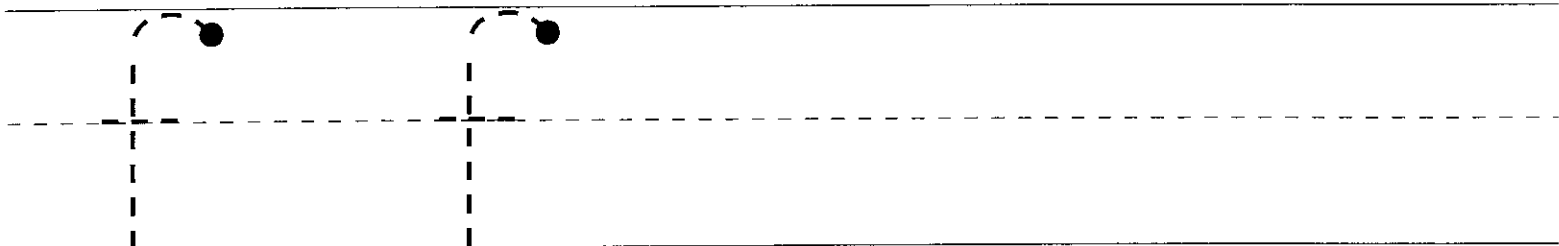
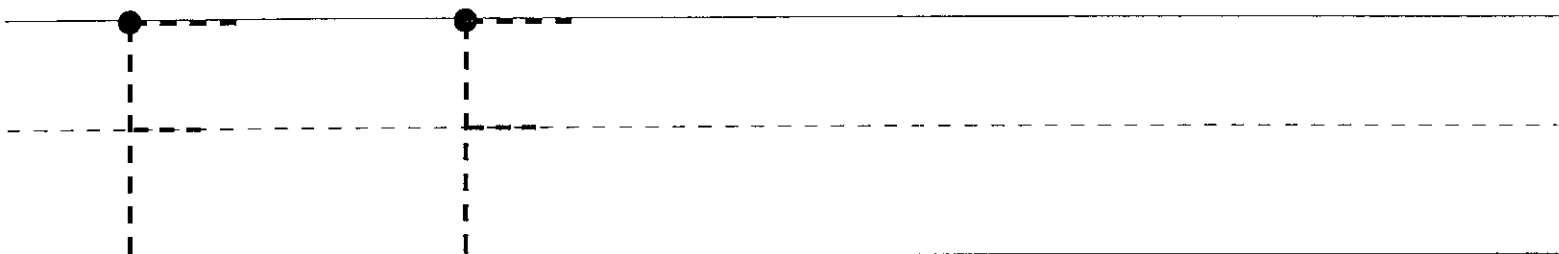

Color all the pictures with this letter sound.

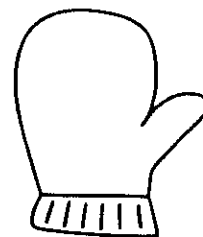
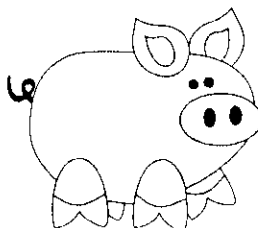
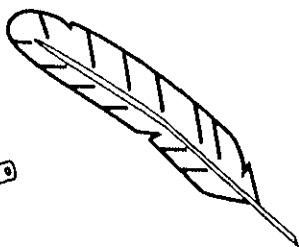
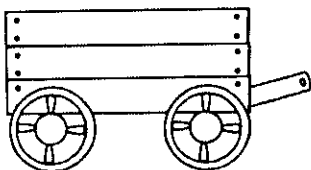
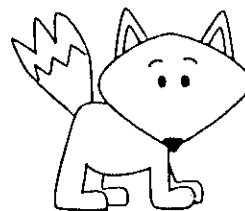
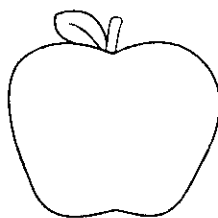
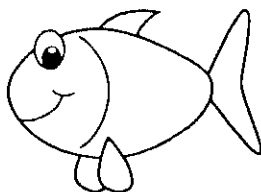
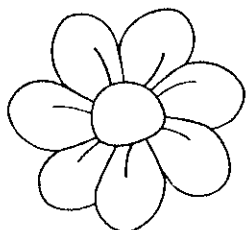

Name: _____

Letter Review



Find the letter

S	G	i	G
g	D	G	g
G	J	g	r
g	n	g	G

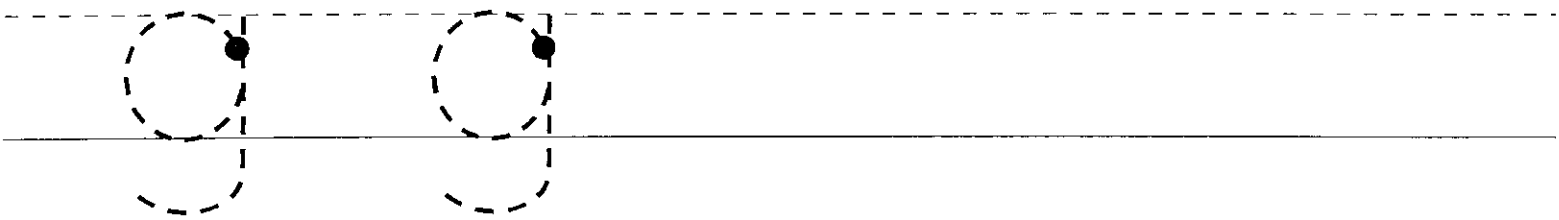
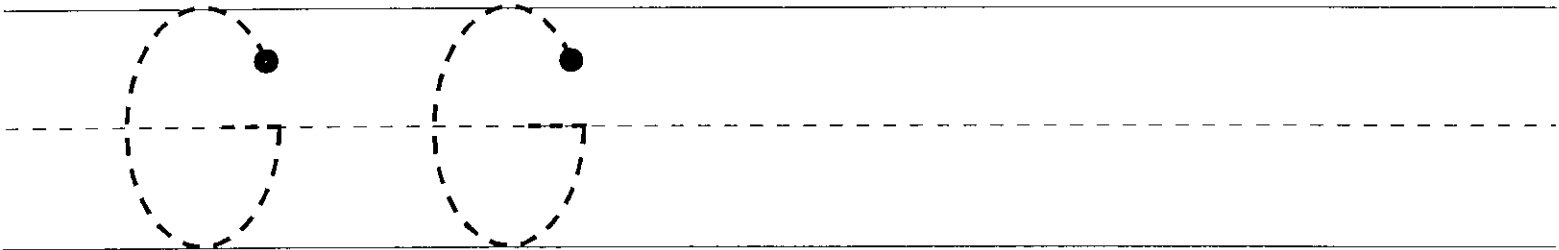

Color all the pictures with this letter sound.

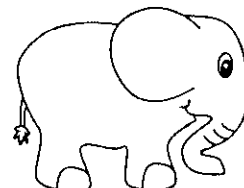
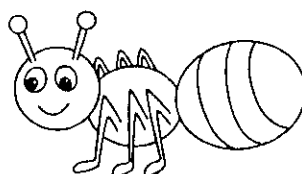
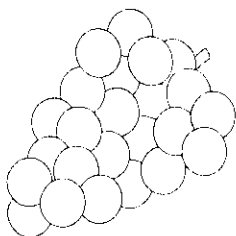
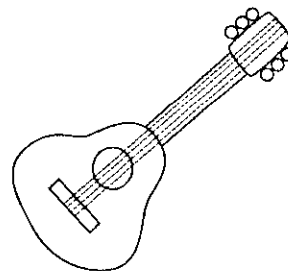
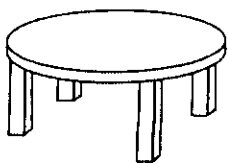

Name: _____

Letter Review

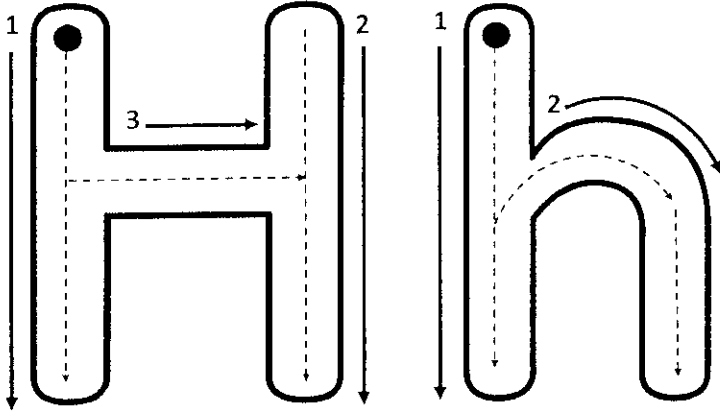

Find the letter

H	R	t	h
x	h	H	P
h	H	O	H
e	h	H	h

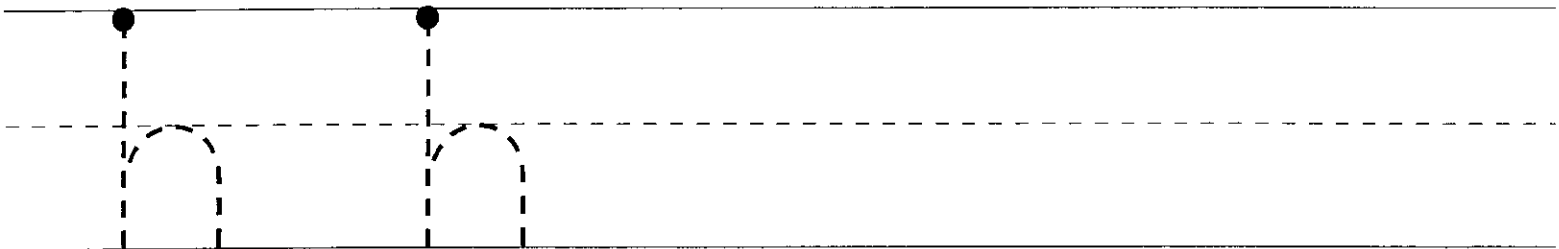
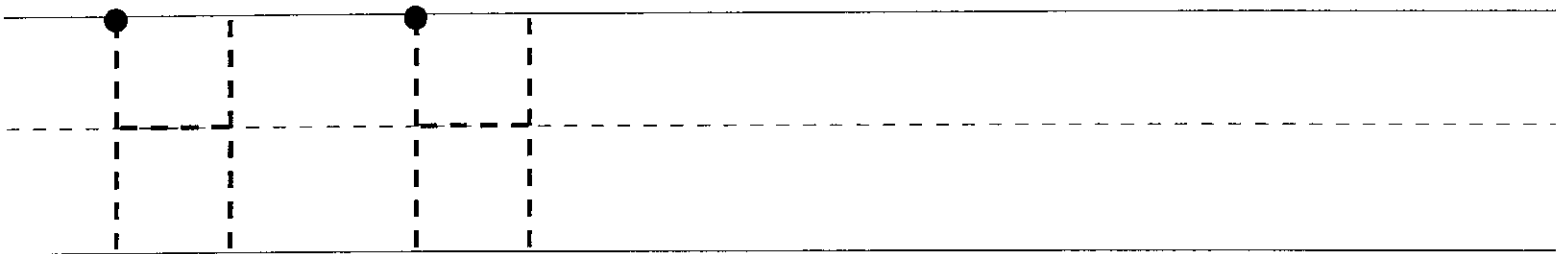

Color all the pictures with this letter sound.

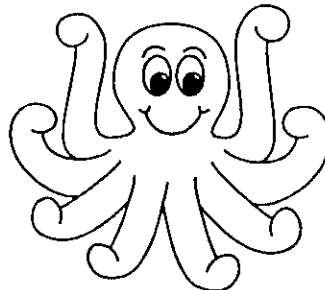
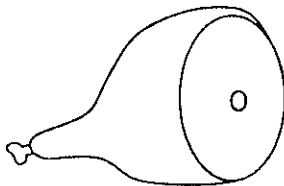
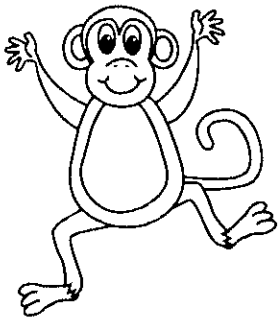
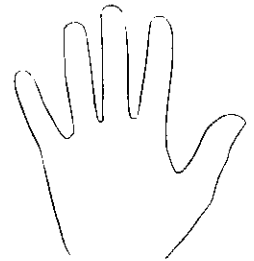
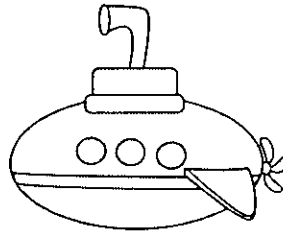
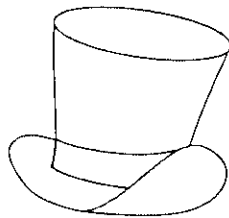
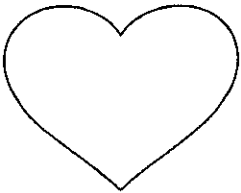

Name: _____

Letter Review

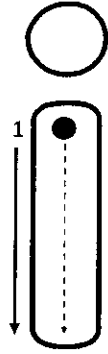
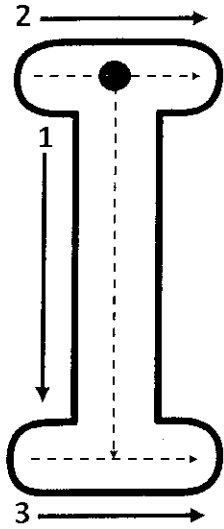

Find the letter

C	i	I	Q
i	I	y	i
I	i	Z	I
i	m	I	L

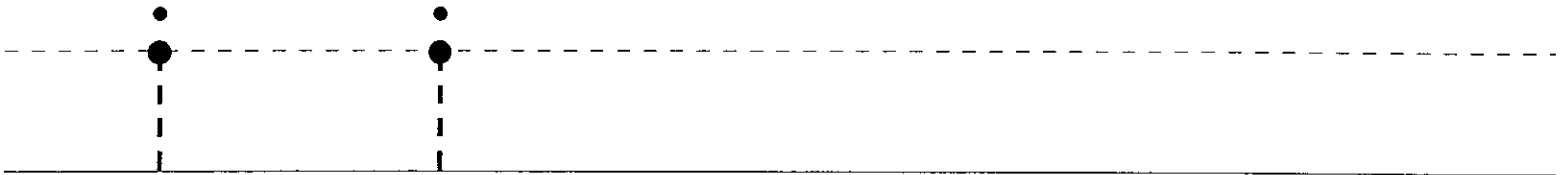
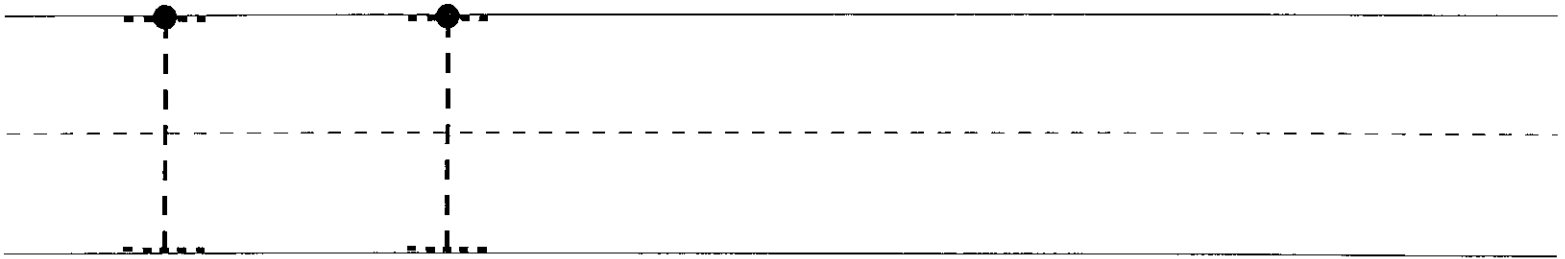

Color all the pictures with this letter sound.

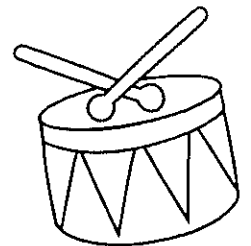
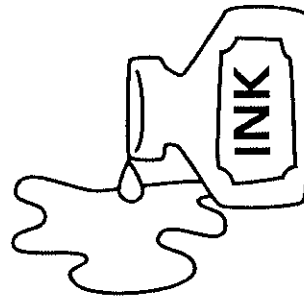
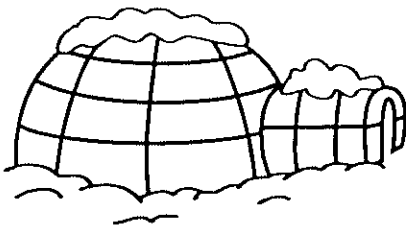
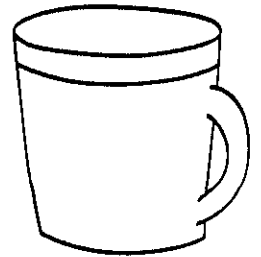
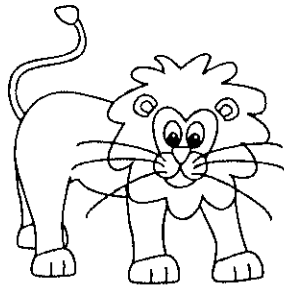
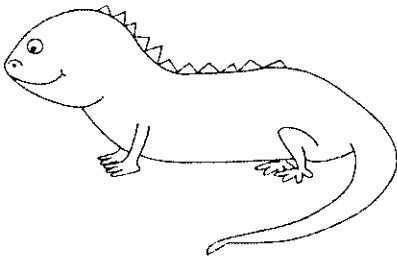

Name: _____

Letter Review

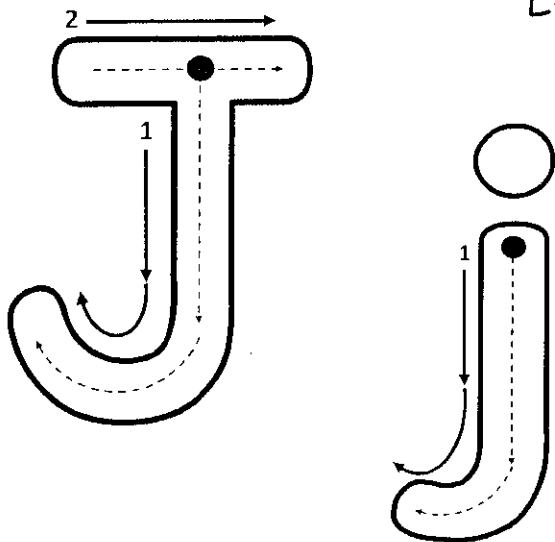

Find the letter

J	F	j	j
W	A	J	r
J	j	O	J
j	k	J	j

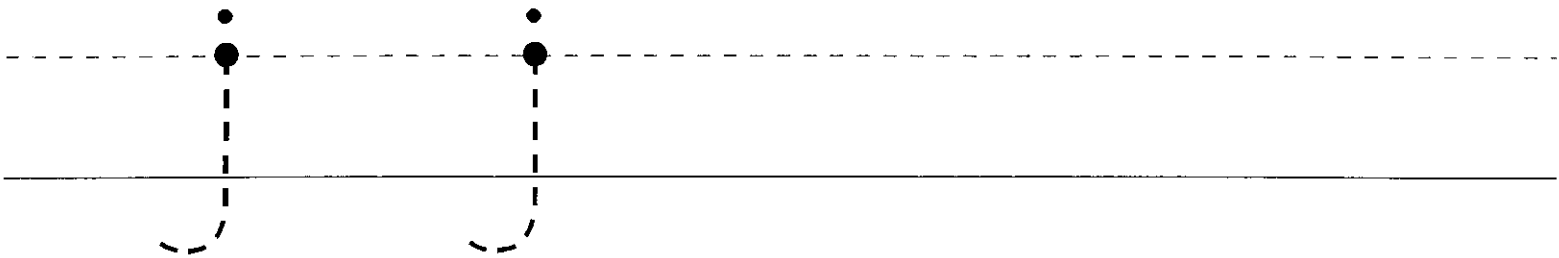
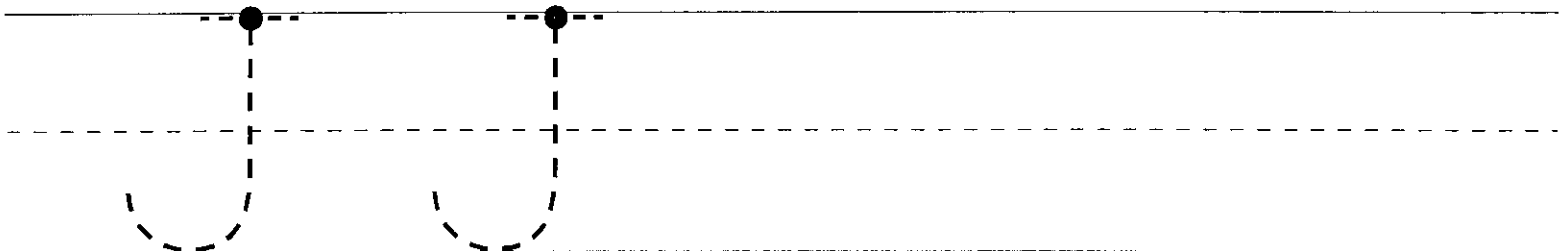

Color all the pictures with this letter sound.

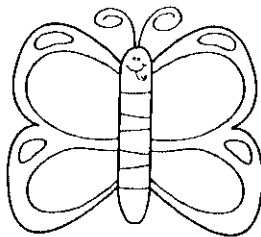
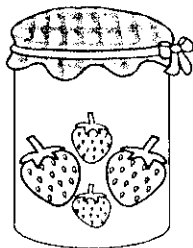
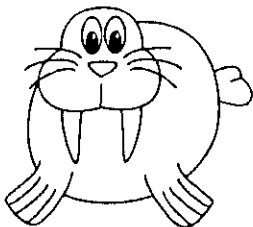
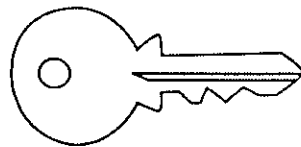
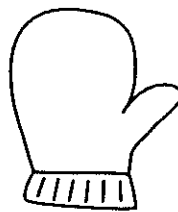
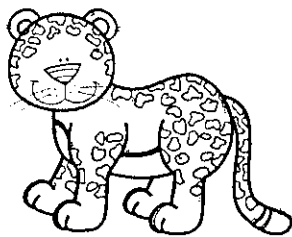
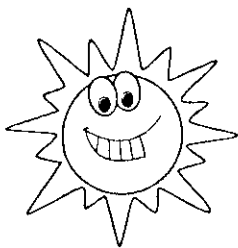
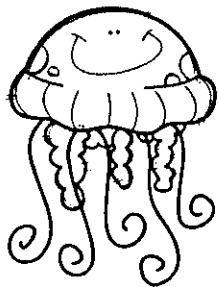

Name: _____

Letter Review

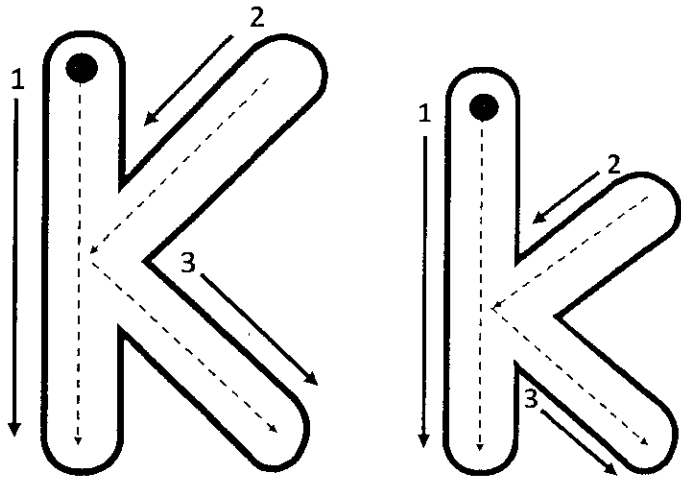

Find the letter

S	k	K	f
K	R	k	K
c	k	K	k
h	K	d	k

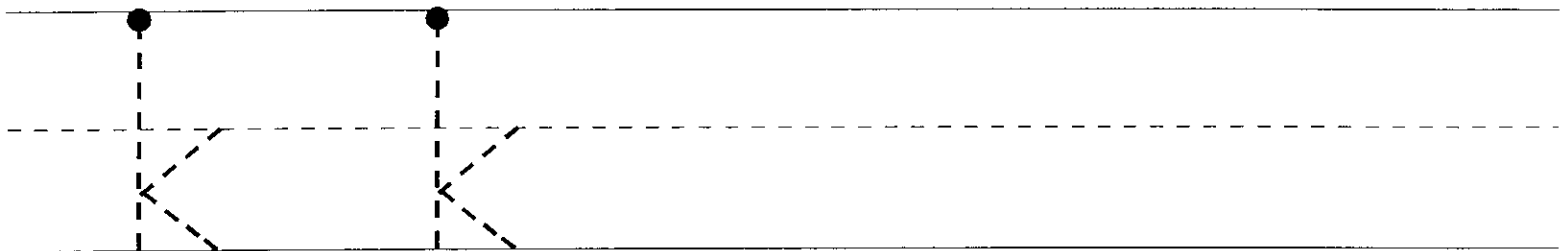
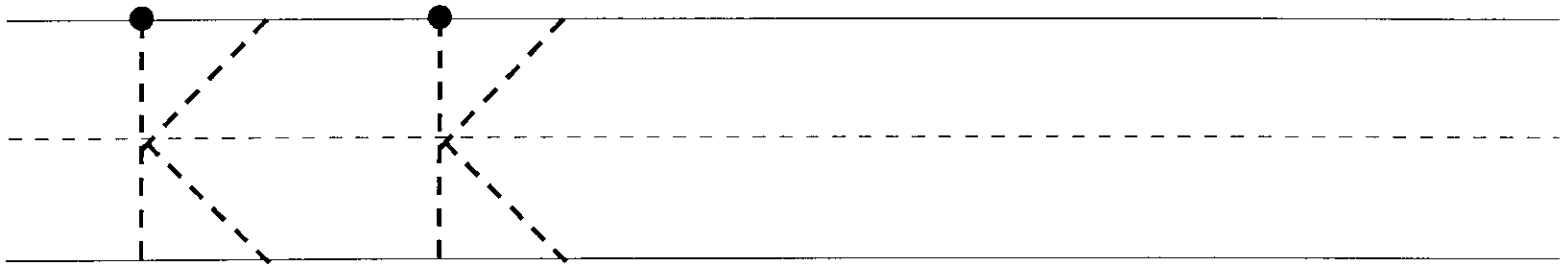

Color all the pictures with this letter sound.

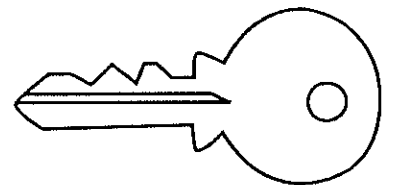
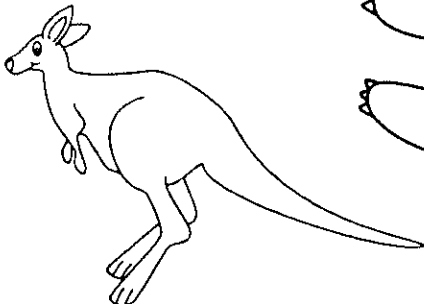
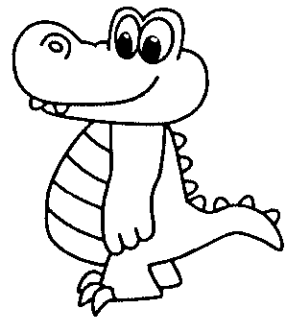
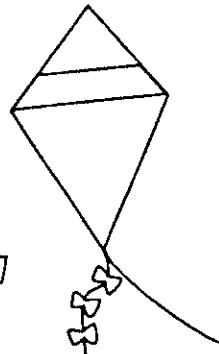
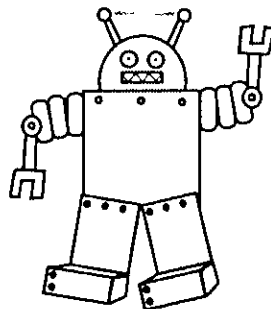
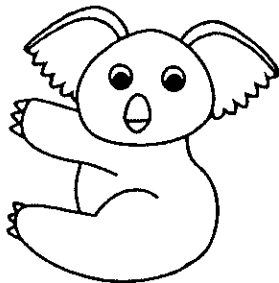
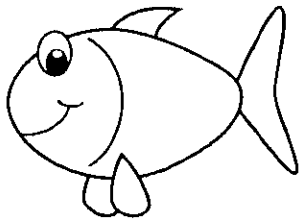

Name: _____

Letter Review

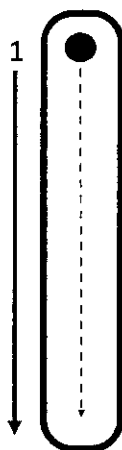
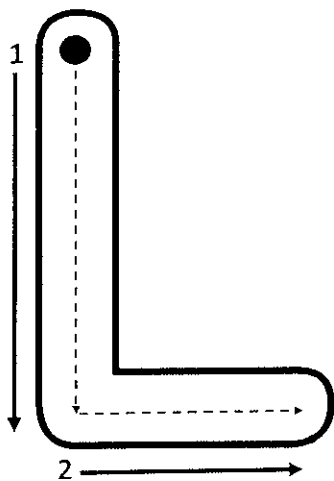

Find the letter

L	V	l	n
l	L	b	L
l	z	L	l
t	L	l	G

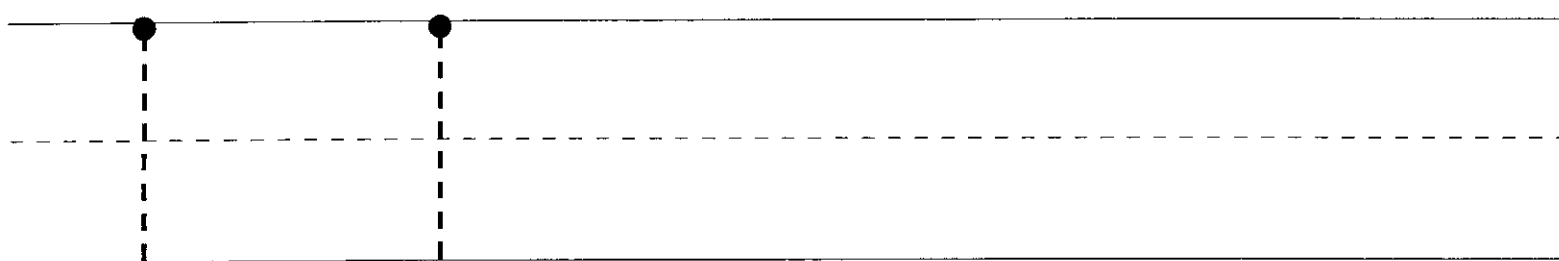
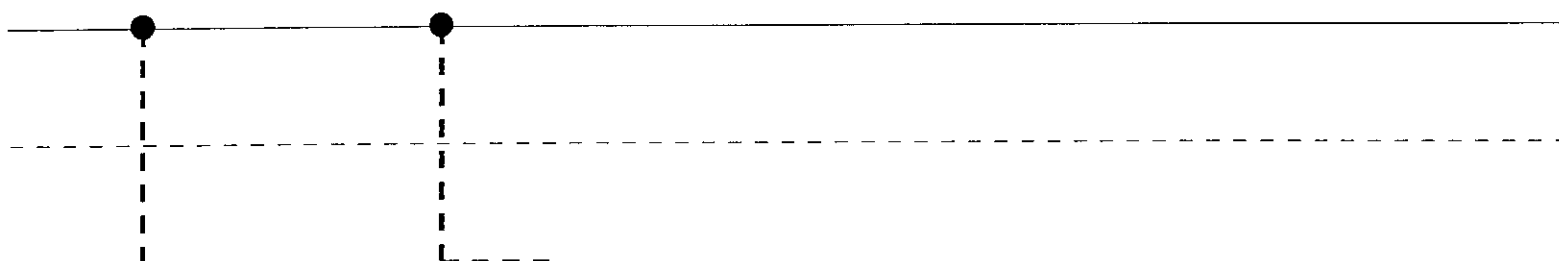

Color all the pictures with this letter sound.

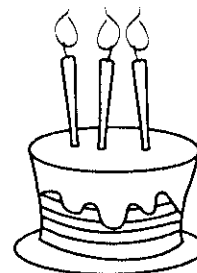
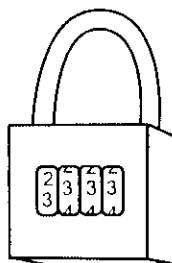
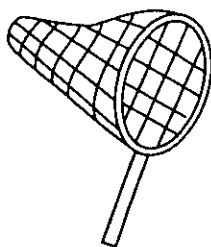
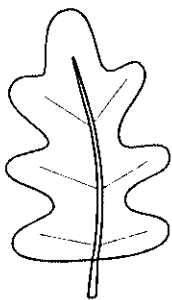
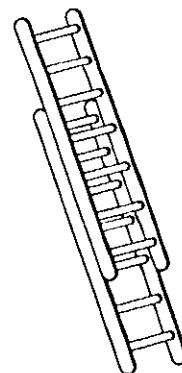
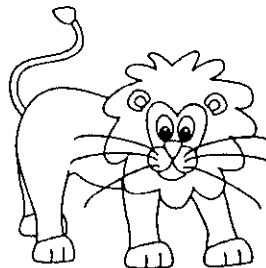
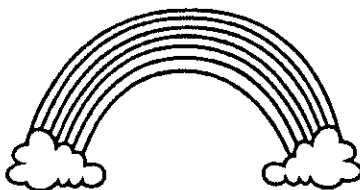
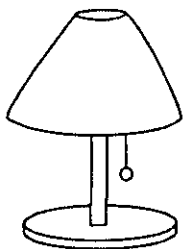

Name: _____

Letter Review

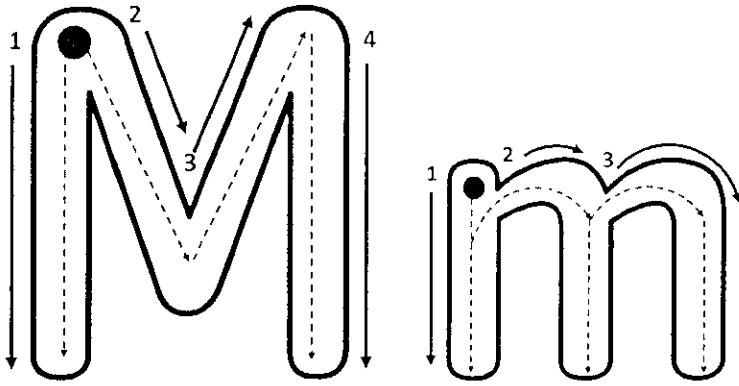

Find the letter

R	M	d	M
m	Q	M	m
M	U	m	h
m	k	m	M

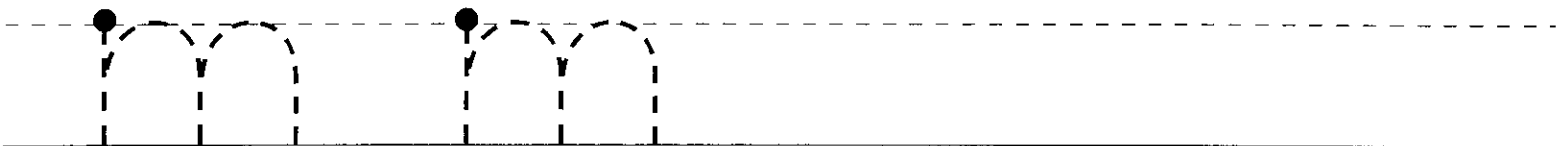
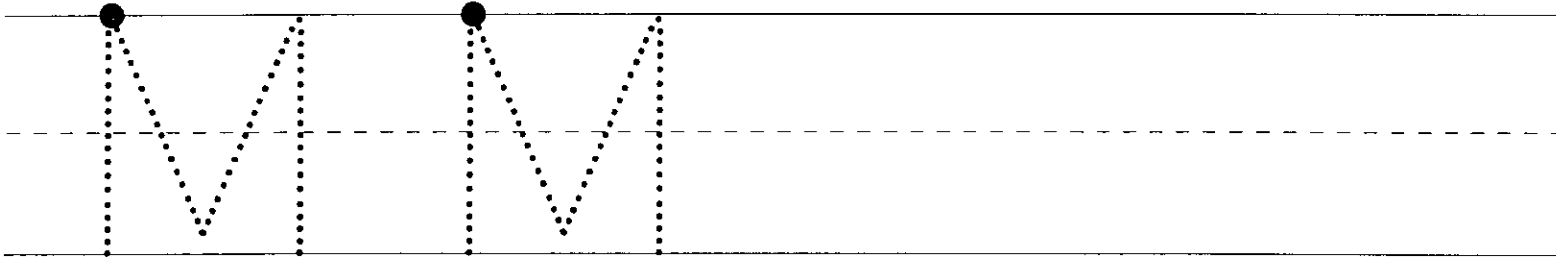

Color all the pictures with this letter sound.

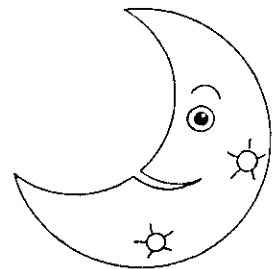
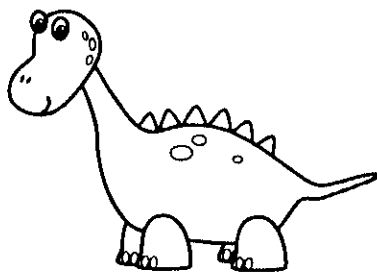
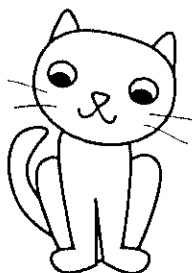
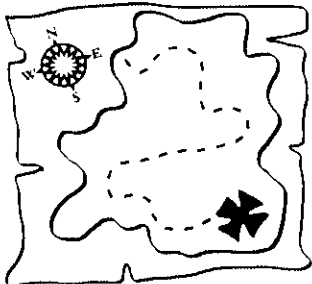
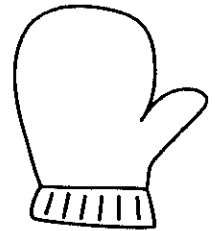
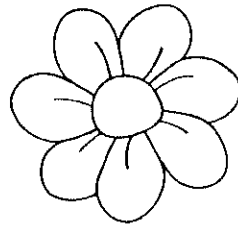
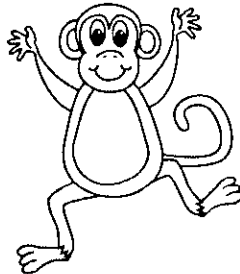
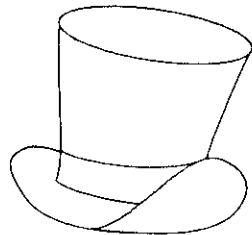

Name: _____

Letter Review

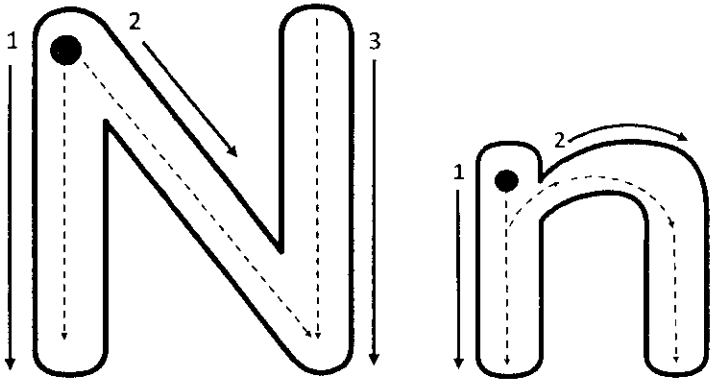

Find the letter

N	D	n	e
j	N	y	N
n	w	N	n
N	n	n	Q

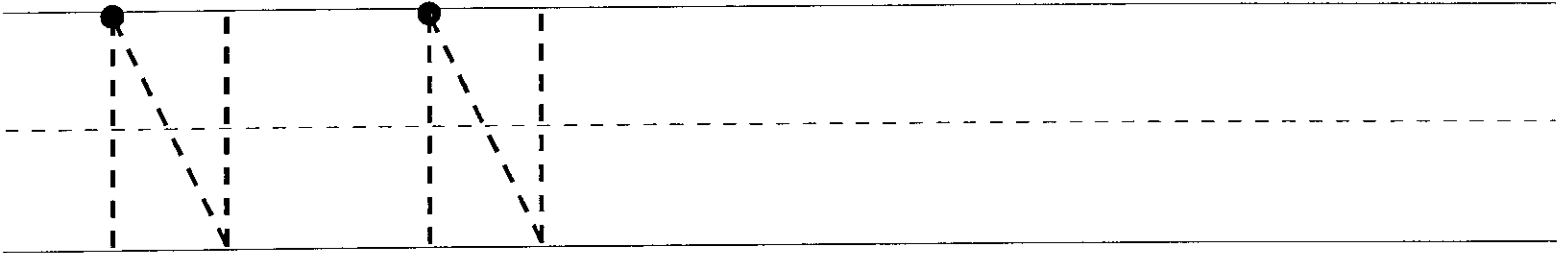

Color all the pictures with this letter sound.

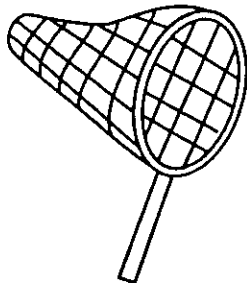
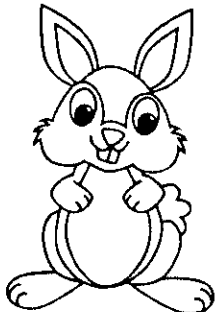
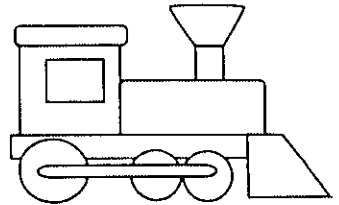
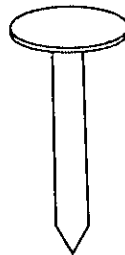
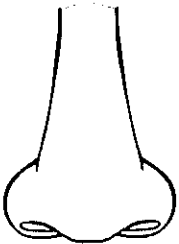

Name: _____

Letter Review

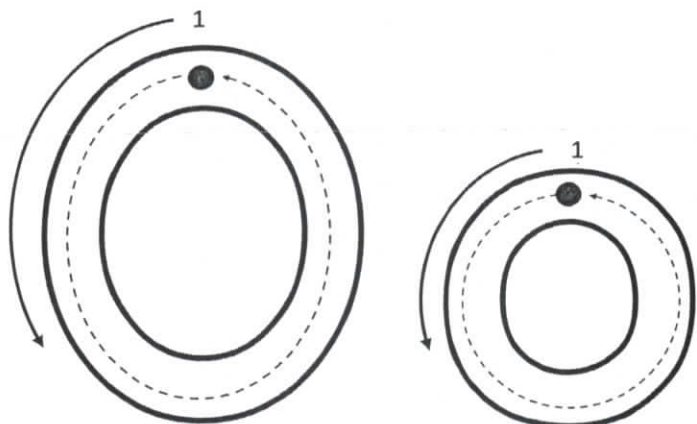

Find the letter

O	R	o	O
s	o	O	P
F	O	q	o
o	k	o	O

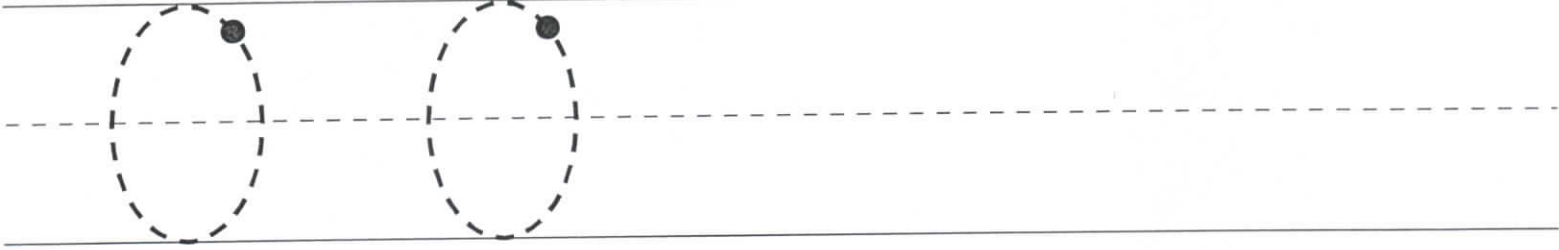

Color all the pictures with this letter sound.

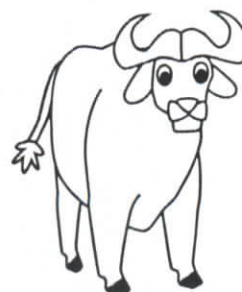
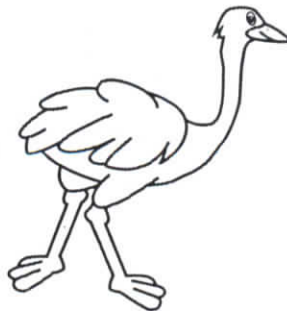
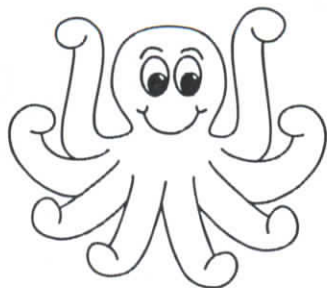
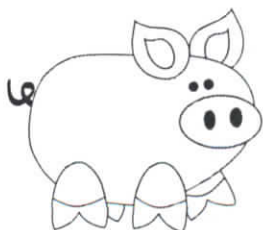

Name: _____

Letter Review

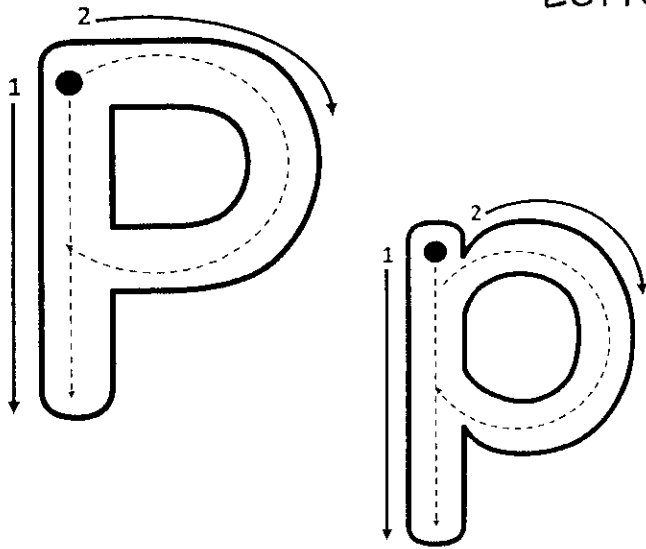

Find the letter

L	P	g	P
p	N	P	p
S	P	W	p
p	X	p	P

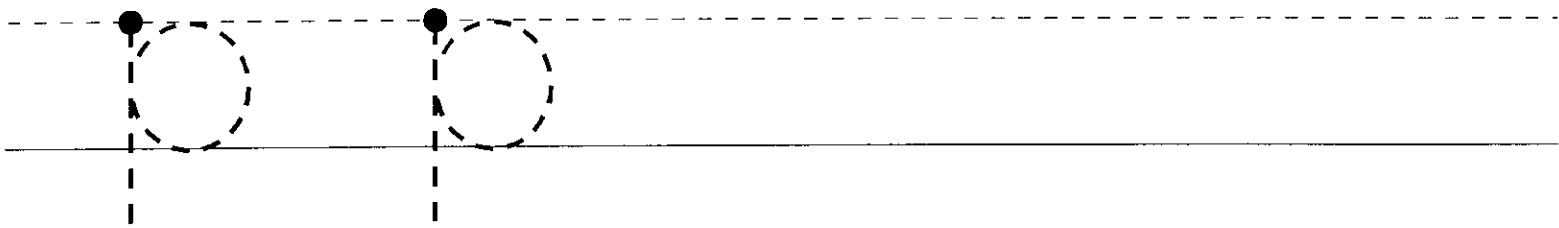
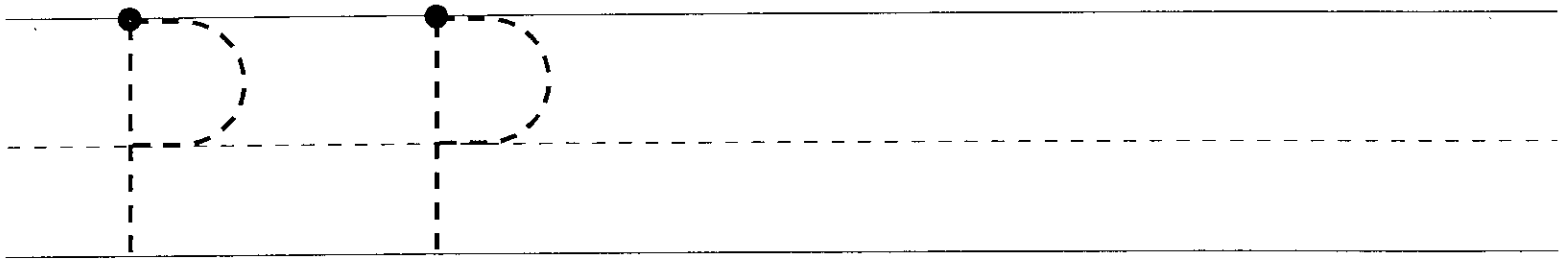

Color all the pictures with this letter sound.

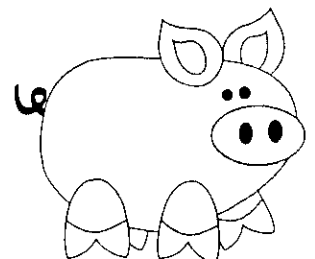
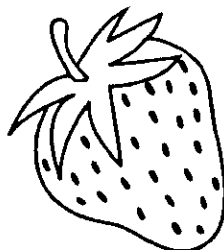
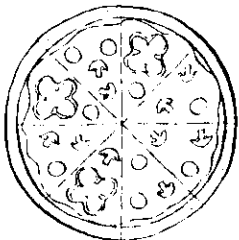
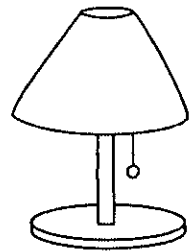
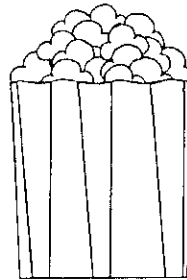
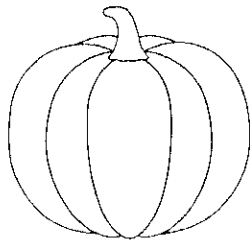
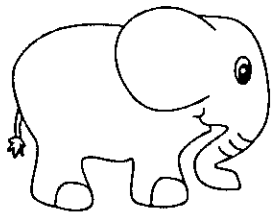

Name: _____

Letter Review

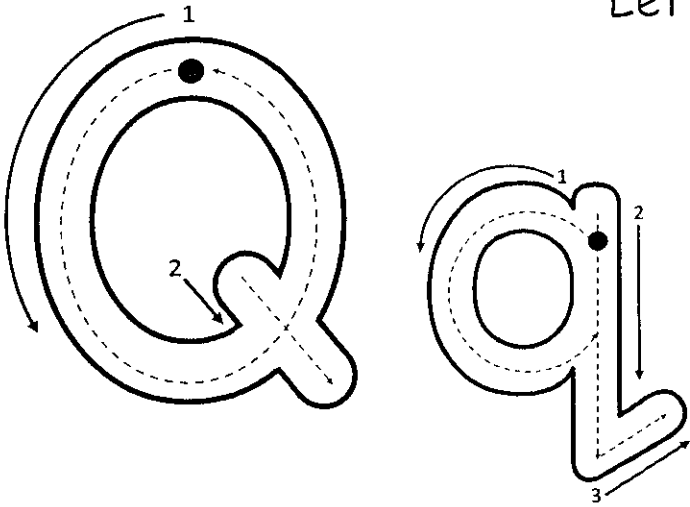

Find the letter

Q	F	Q	q
b	Q	q	k
q	h	q	Q
m	q	Q	E

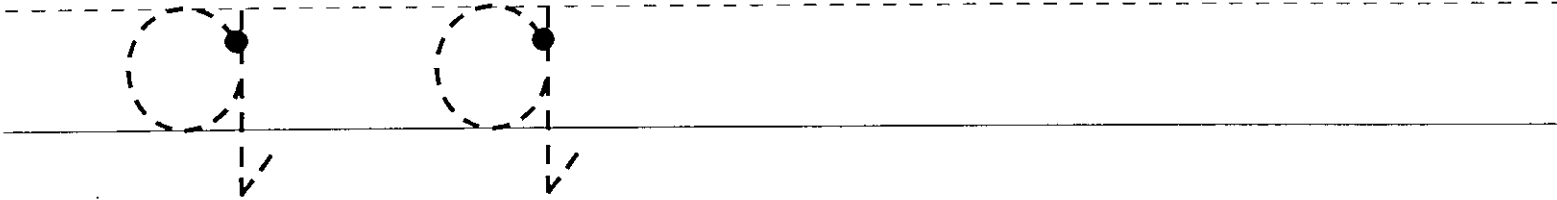
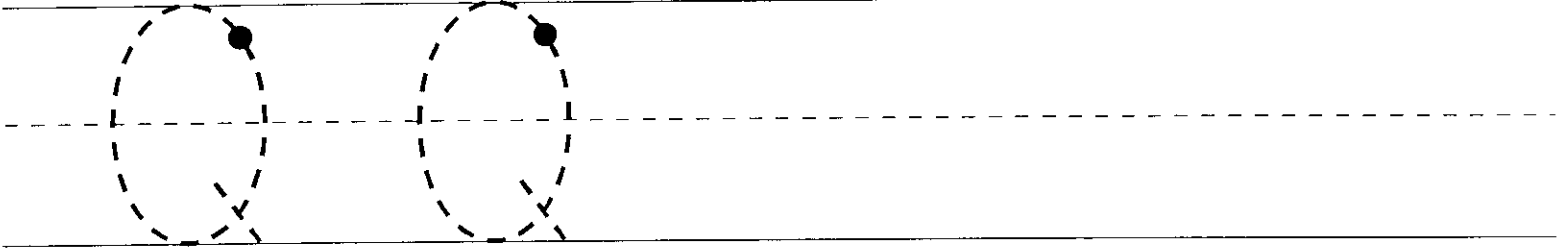

Color all the pictures with this letter sound.

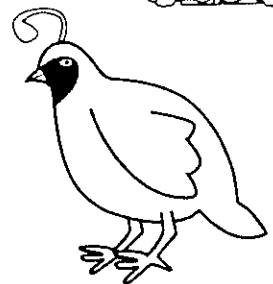
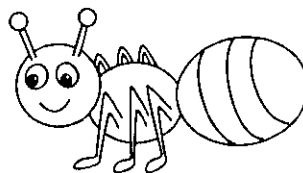
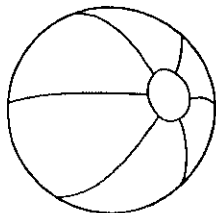
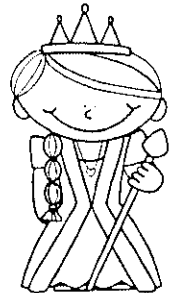
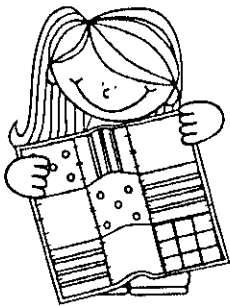

Name: _____

Letter Review

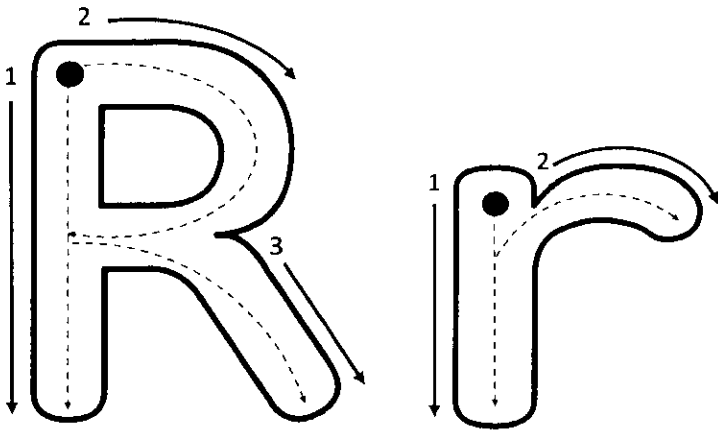

Find the letter

r	R	B	r
a	r	R	Z
M	R	r	R
R	O	t	r

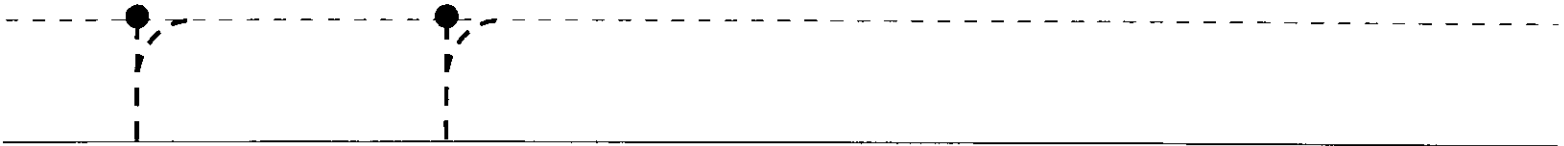
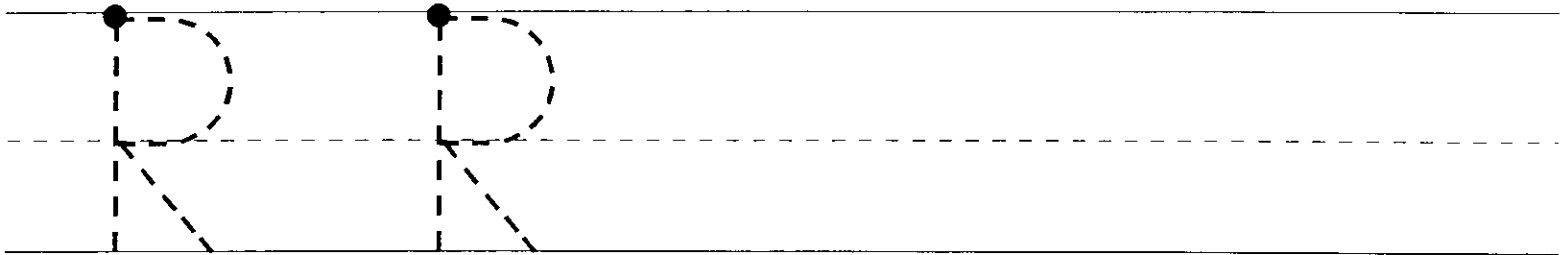

Color all the pictures with this letter sound.

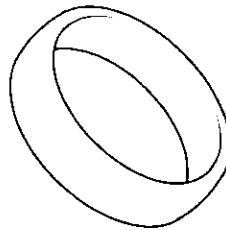
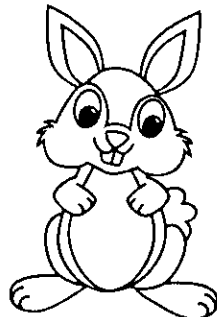
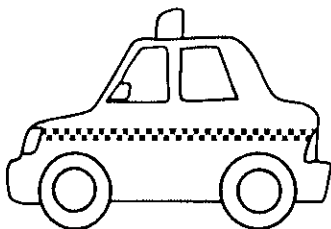
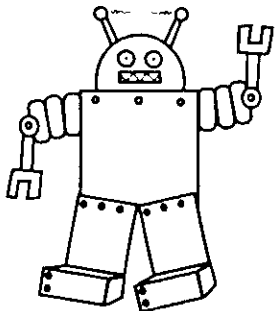
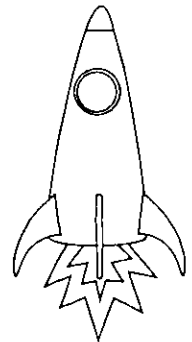
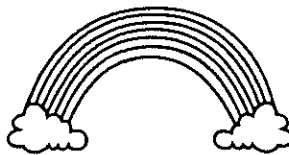
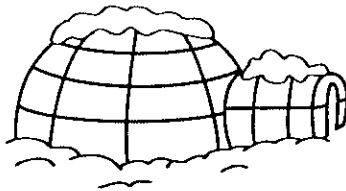
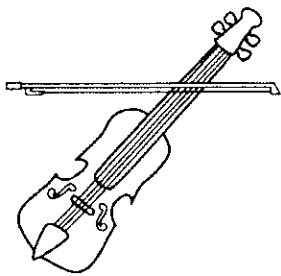

Name: _____

Letter Review

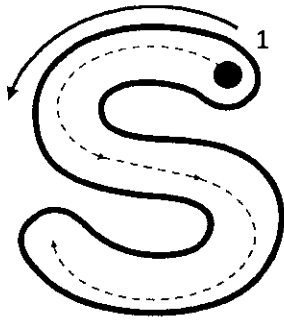
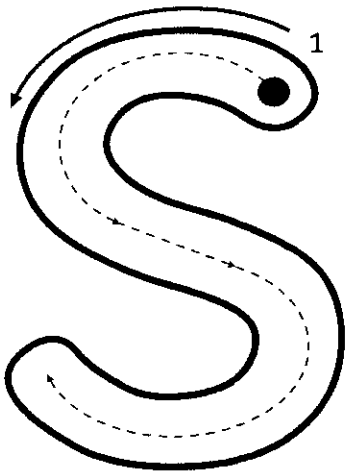

Find the letter

T	S	p	S
S	N	S	C
s	S	s	h
S	V	S	S

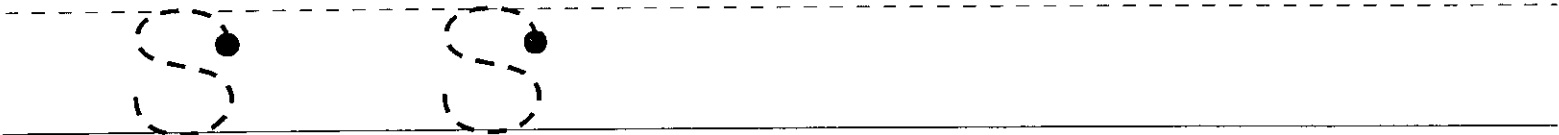
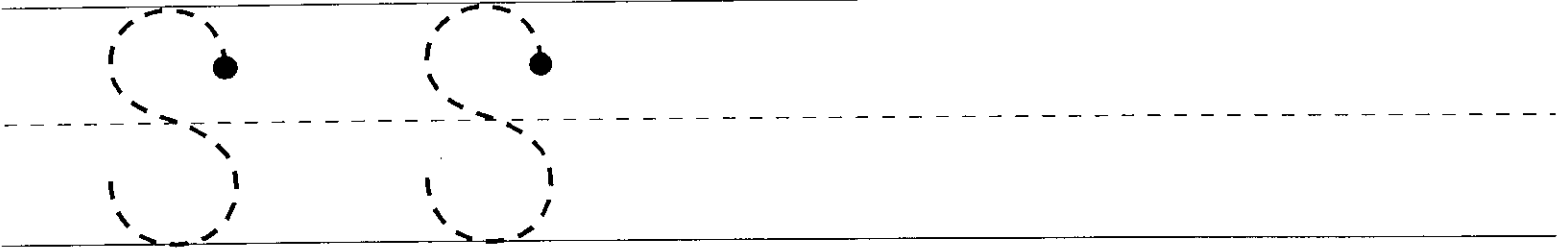

Color all the pictures with this letter sound.

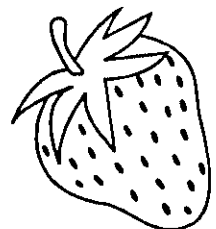
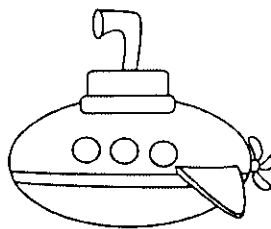
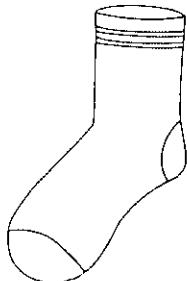
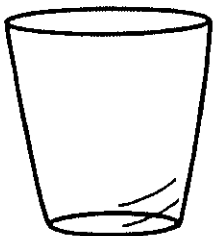
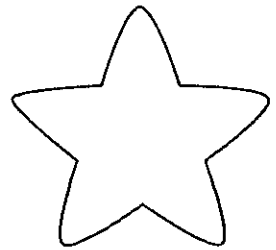
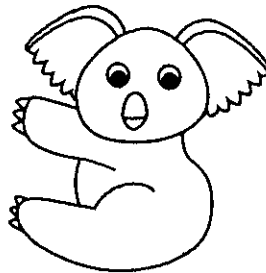
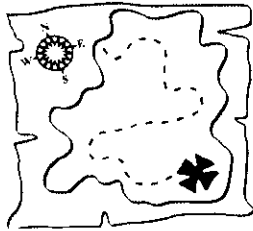
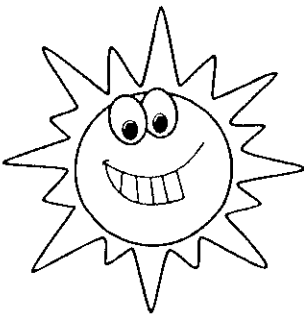

Name: _____

Letter Review

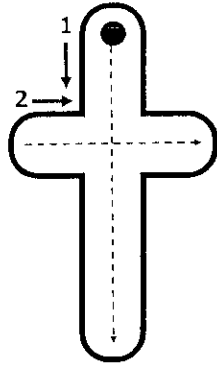
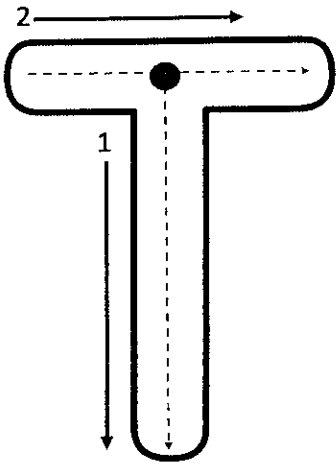

Find the letter

T	k	T	t
g	T	t	S
t	O	t	T
r	t	T	B

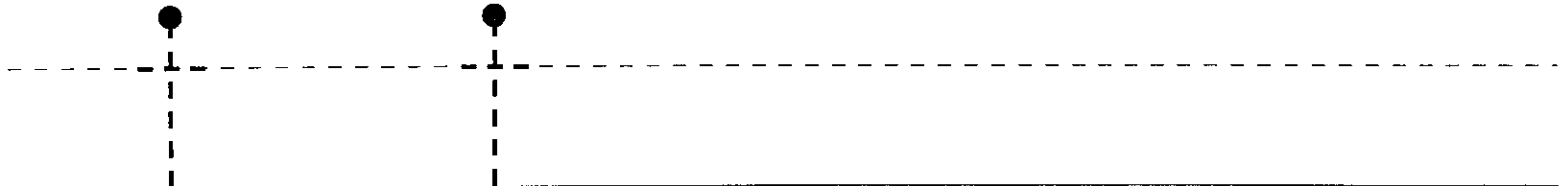
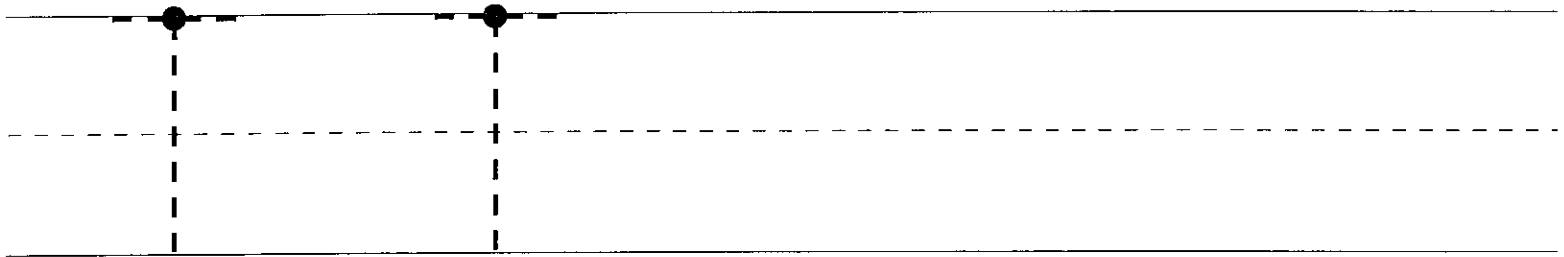

Color all the pictures with this letter sound.

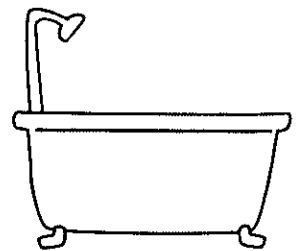
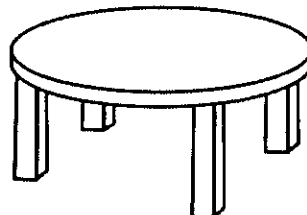
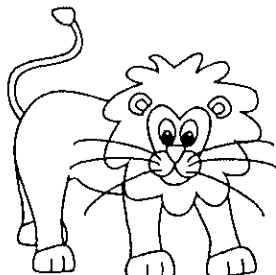
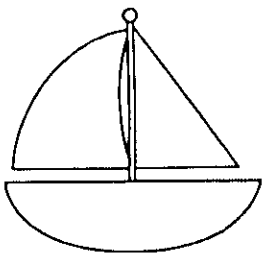
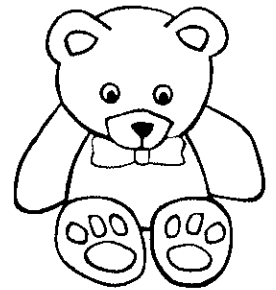
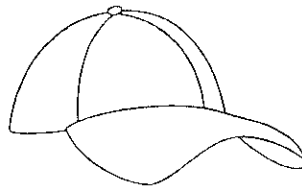
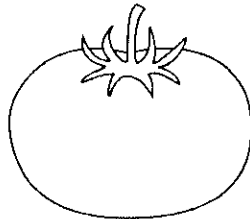
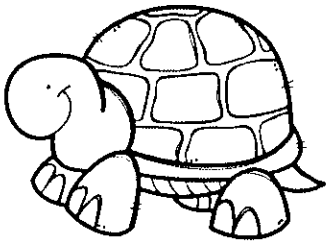

Name: _____

Letter Review

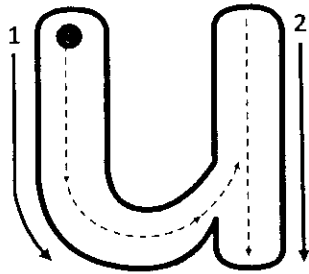
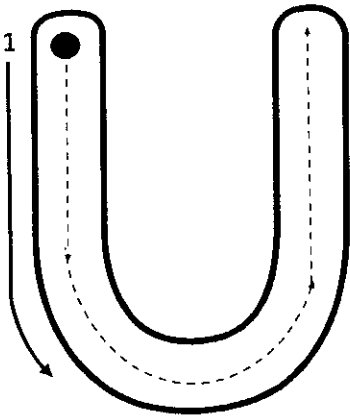

Find the letter

U	u	U	H
b	U	e	u
Y	u	W	U
u	a	U	u

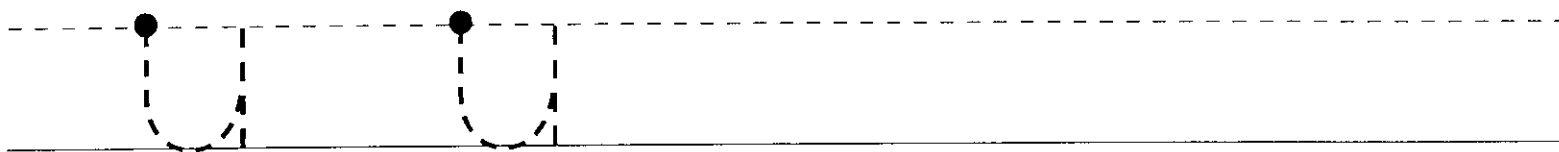
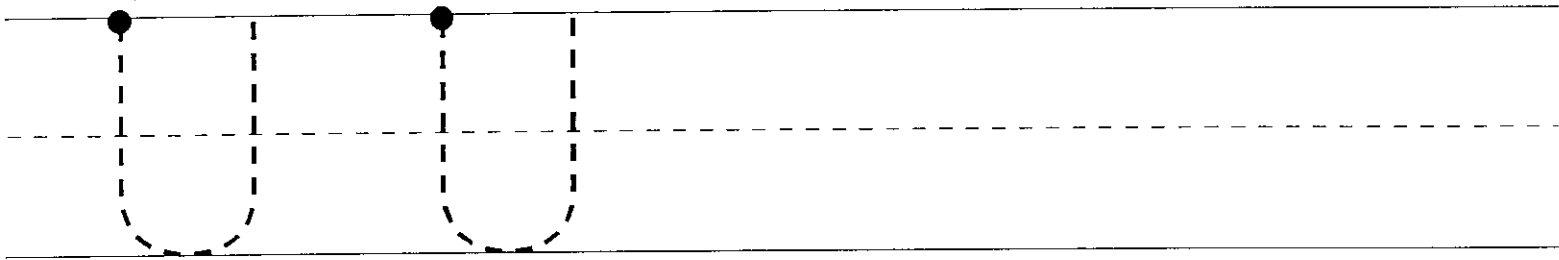

Color all the pictures with this letter sound.

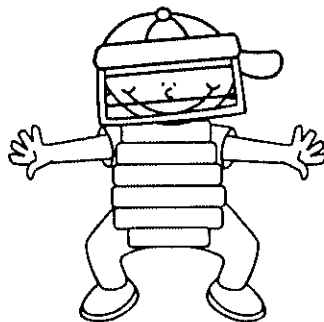
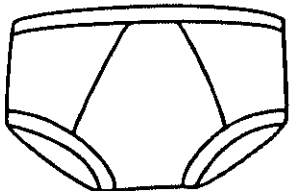
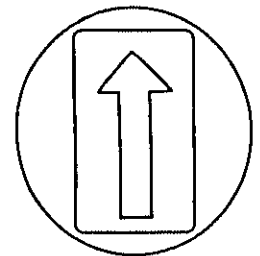
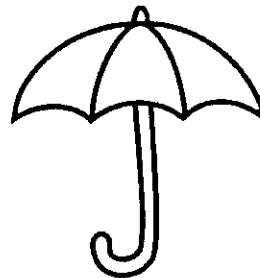
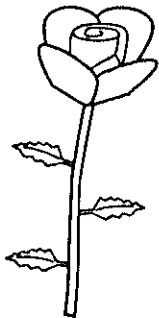
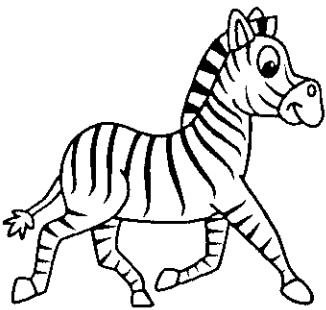

Name: _____

Letter Review

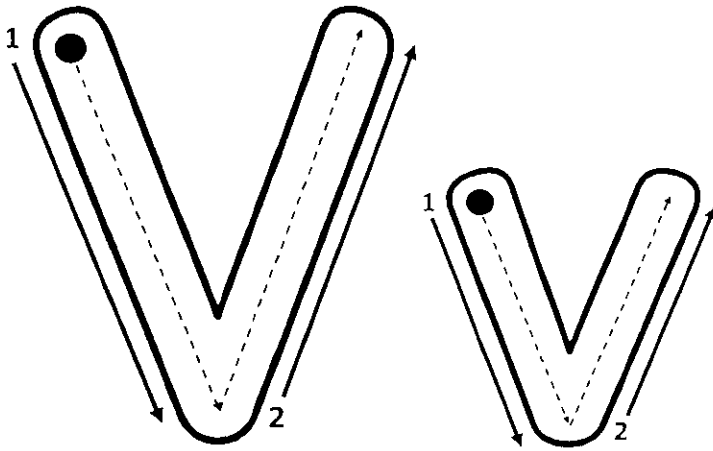

Find the letter

V	g	V	v
l	v	A	V
P	V	v	q
v	O	V	v

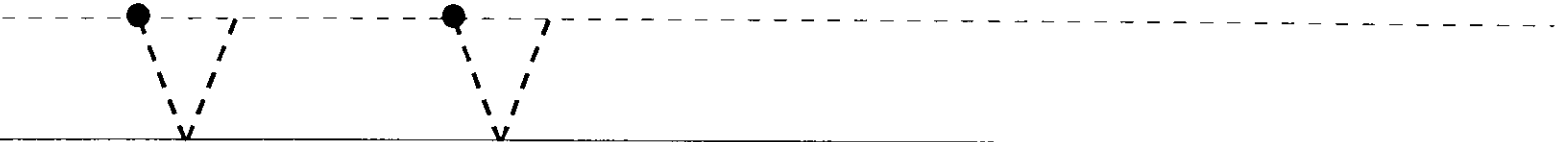
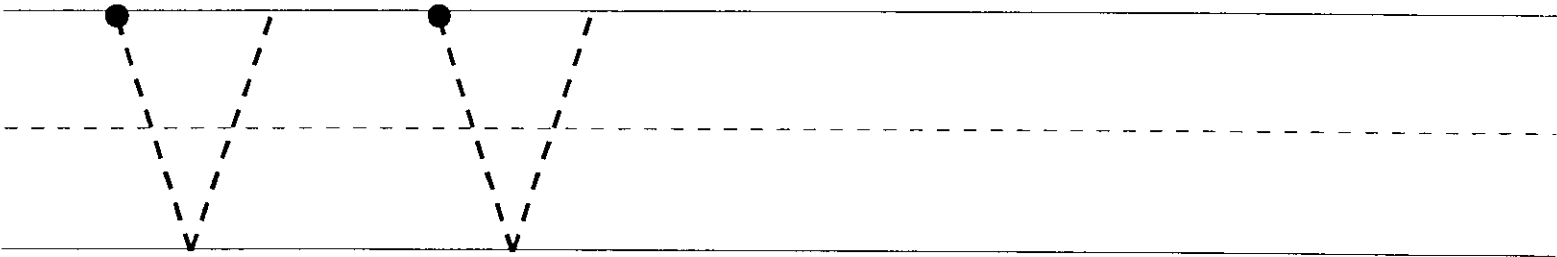

Color all the pictures with this letter sound.

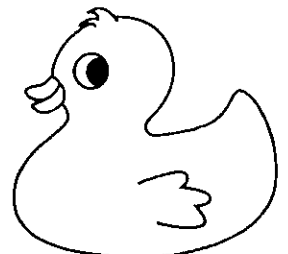
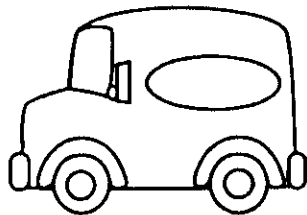
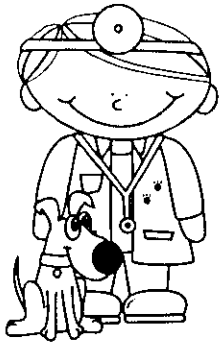
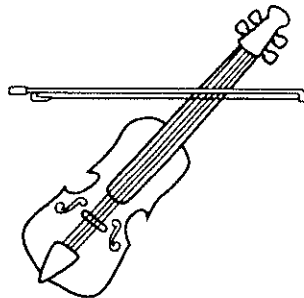
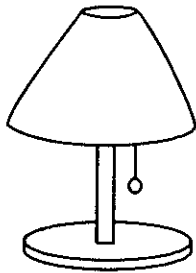
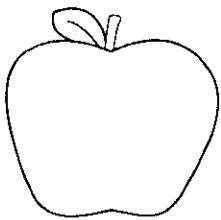

Name: _____

Letter Review

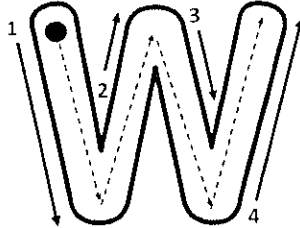
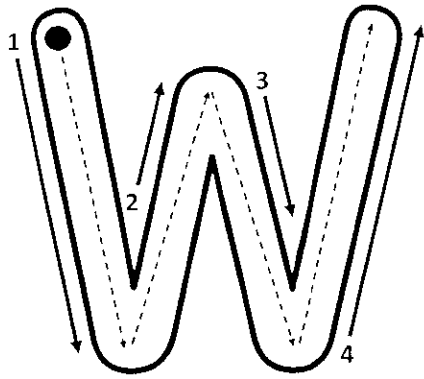

Find the letter

w	W	t	W
n	G	W	w
W	w	S	W
Z	W	w	V

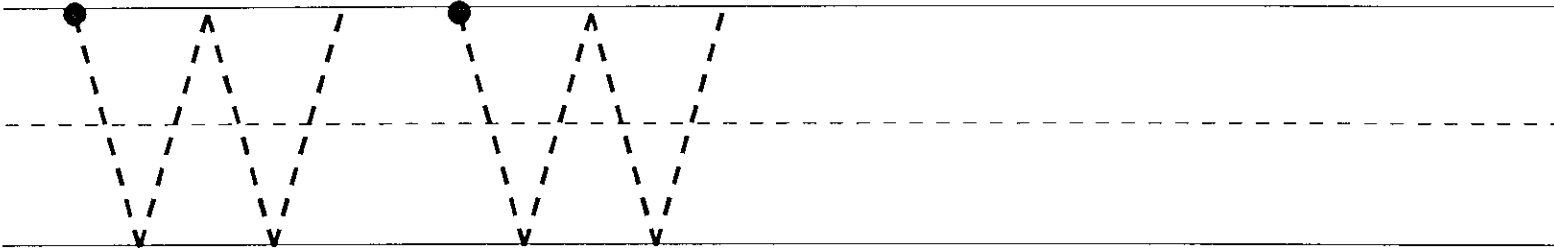

Color all the pictures with this letter sound.

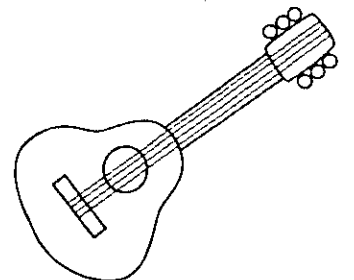
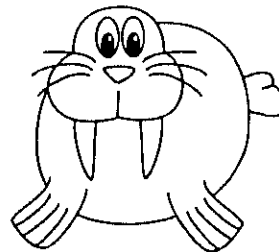
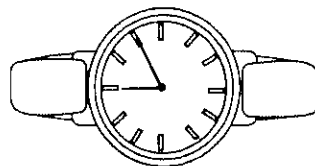
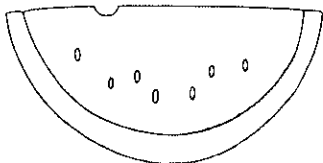
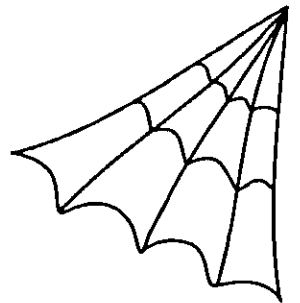
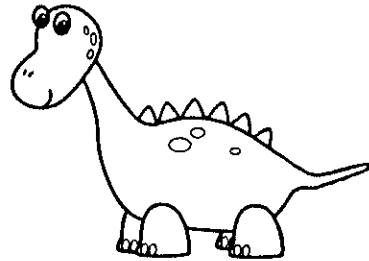
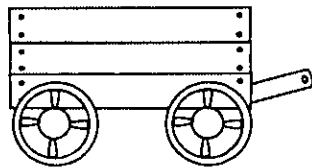
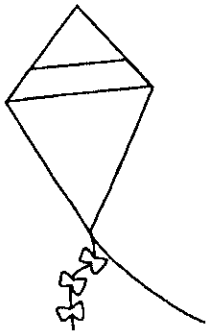

Name: _____

Letter Review

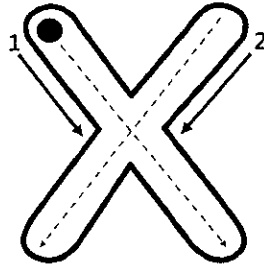
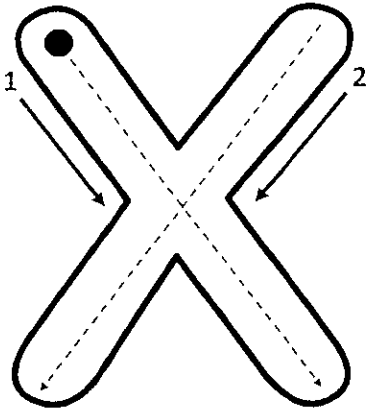

Find the letter

X	I	X	x
c	X	r	x
x	Q	x	X
L	X	x	m

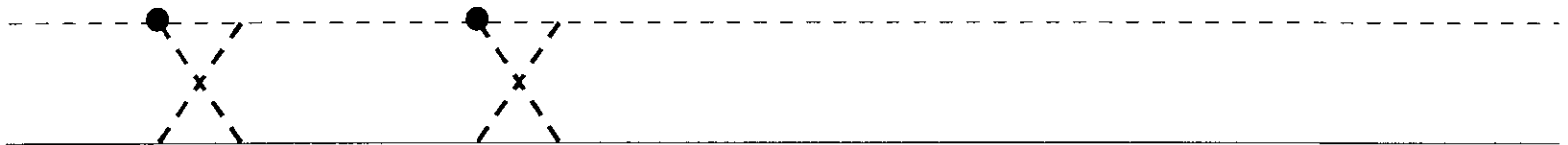
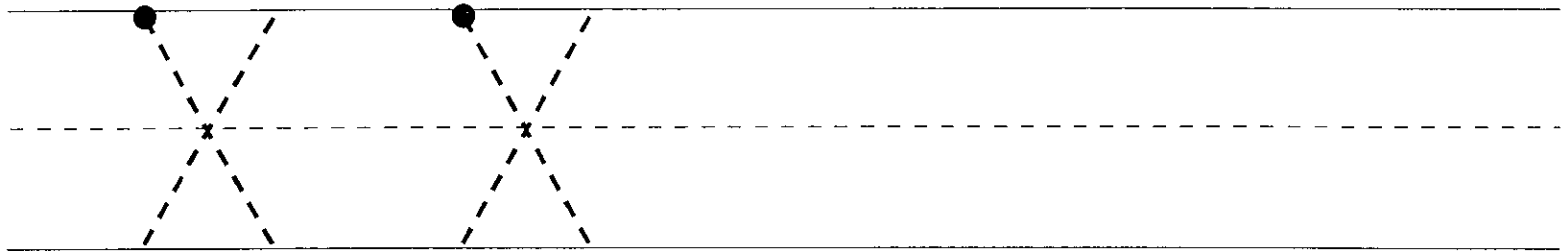

Color all the pictures with this letter sound.

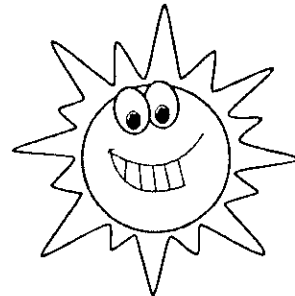
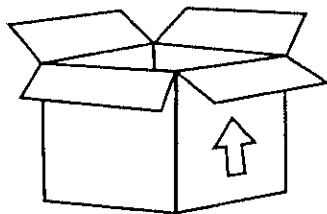
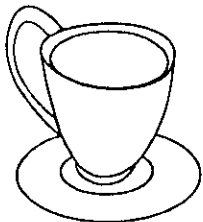
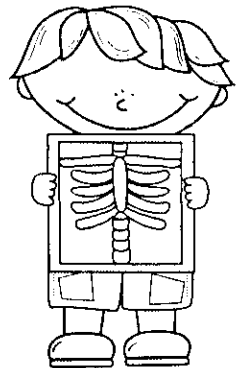
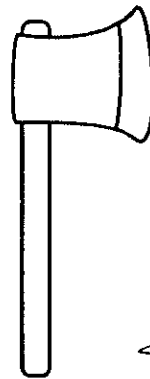
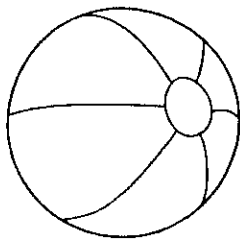
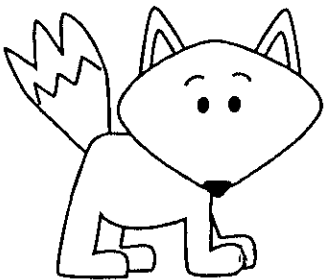

Name: _____

Letter Review

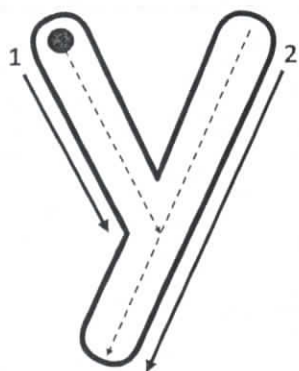
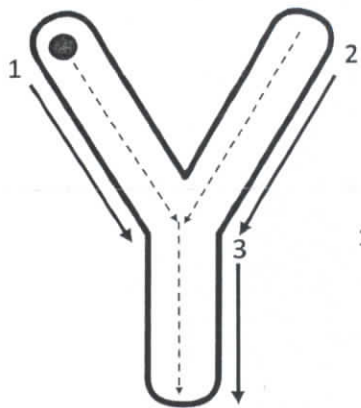

Find the letter

J	Y	b	y
Y	P	Y	M
y	r	y	Y
Y	y	z	y

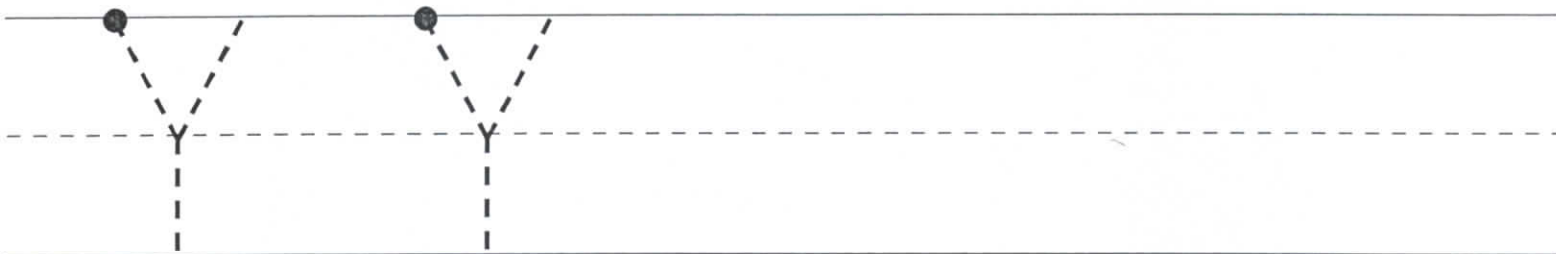

Color all the pictures with this letter sound.

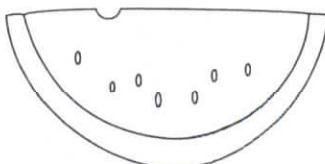
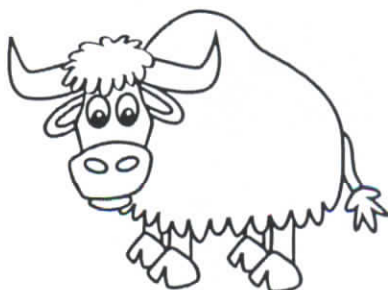
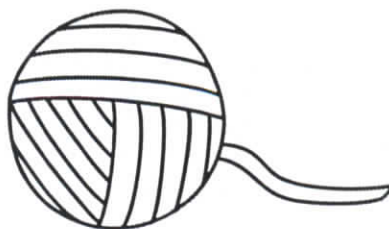

Name: _____

Letter Review

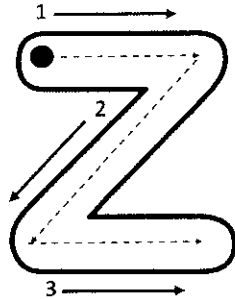
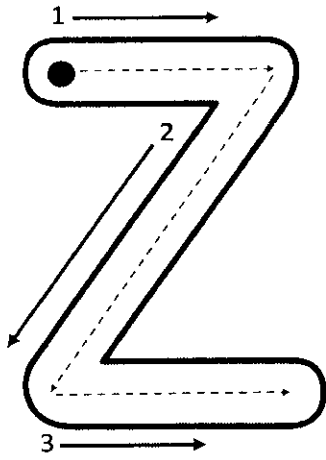

Find the letter

F	Z	z	Z
Z	z	e	z
z	d	Z	V
p	Z	t	z

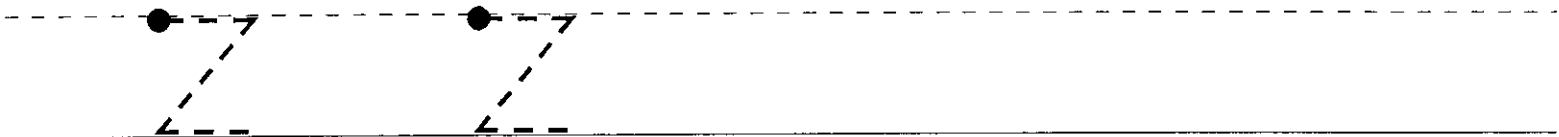
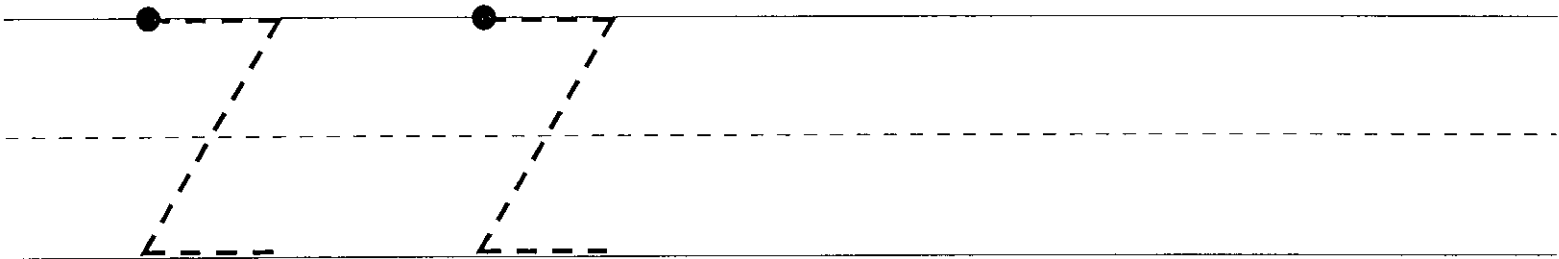

Color all the pictures with this letter sound.

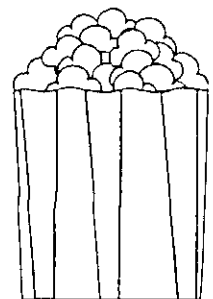
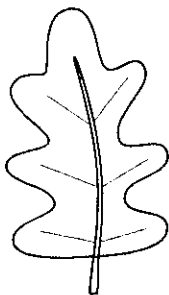
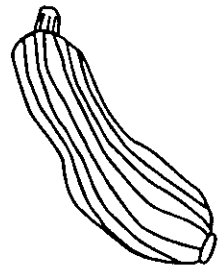
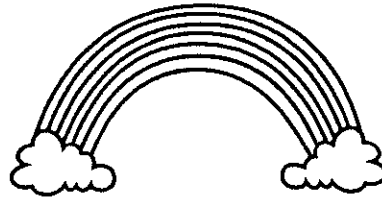
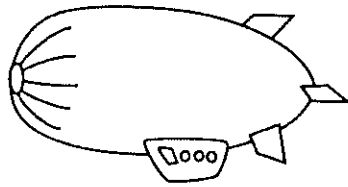
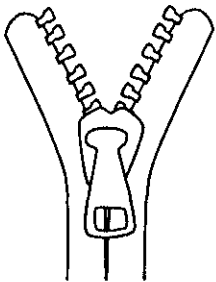

Number Tracing Pre-K Worksheets

By [learning](#) at April 1, 2011 | 5:24 pm | [Print](#)

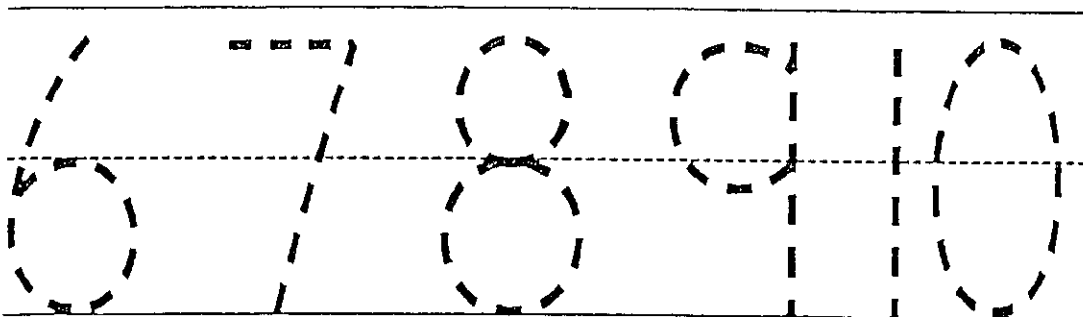
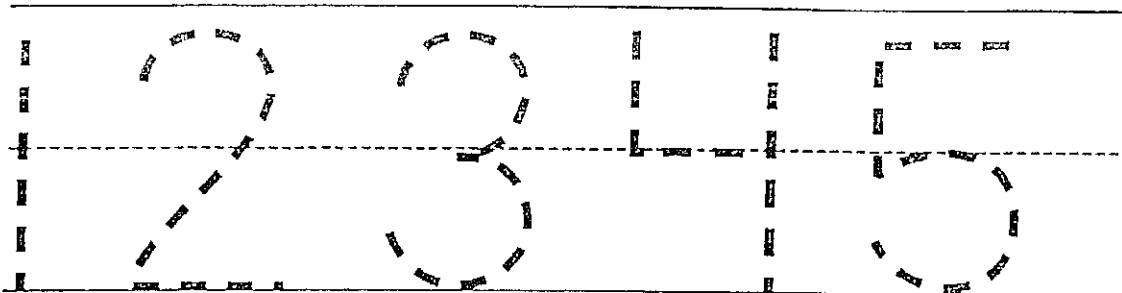
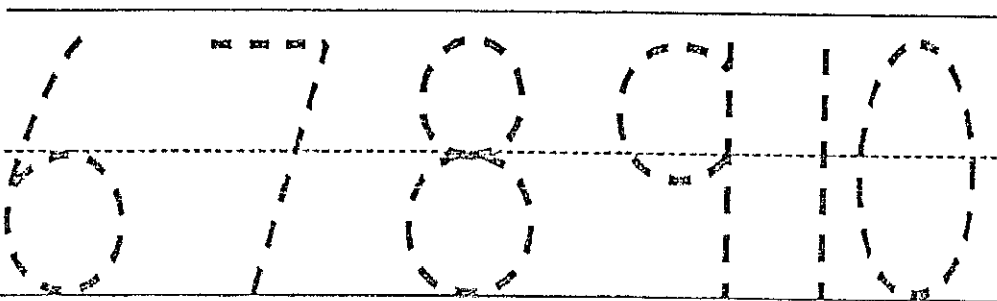
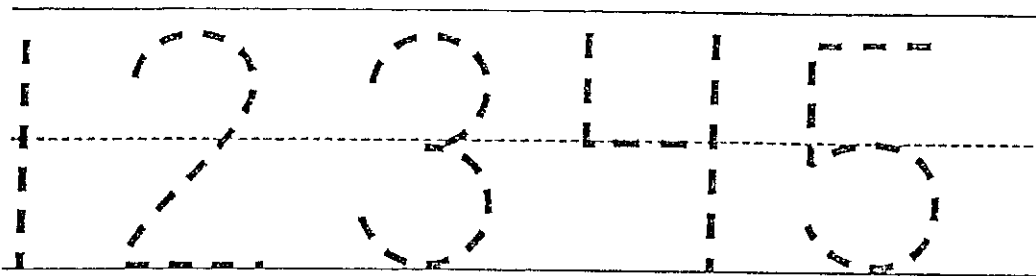

Besides knowing how to identify numbers, preschool children need to learn how to write the basic numbers from 1 to 10. These basic Number Tracing worksheets will help them practice. Just click on the link to print the individual pdf.

Name: _____

Number Review

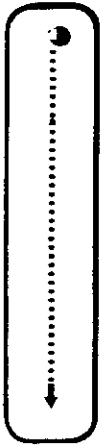

Trace & Write it

Two sets of handwriting lines. Each set consists of a solid top line, a dashed middle line, and a solid bottom line. The first set has three vertical dotted lines starting from the top line and ending at the bottom line, each with a solid dot at the top. The second set also has three vertical dotted lines with solid dots at the top.

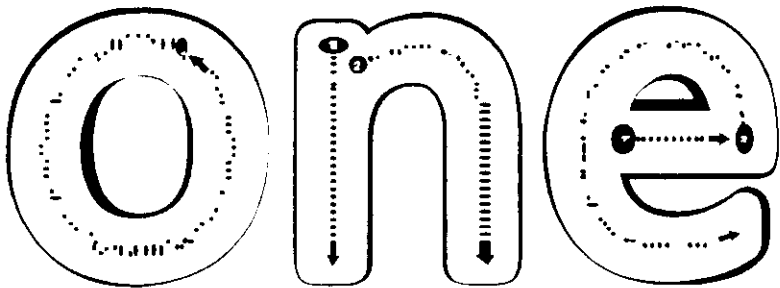

Color 1 picture

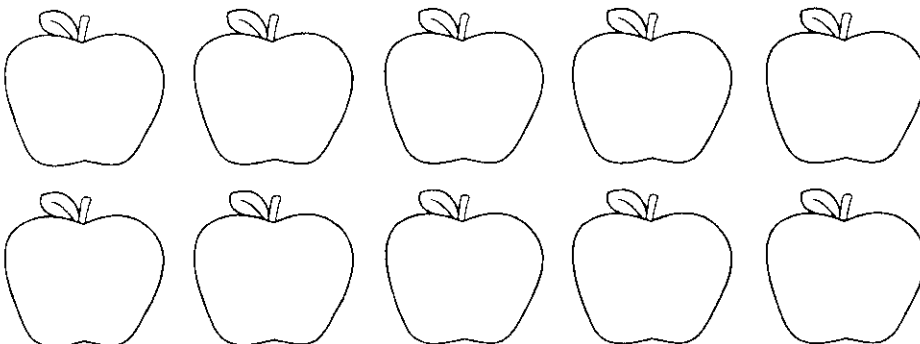

Find the number

1	4	2	6
5	1	1	9
1	3	1	8
7	1	10	1

Name: _____

Number Review



Trace & Write it

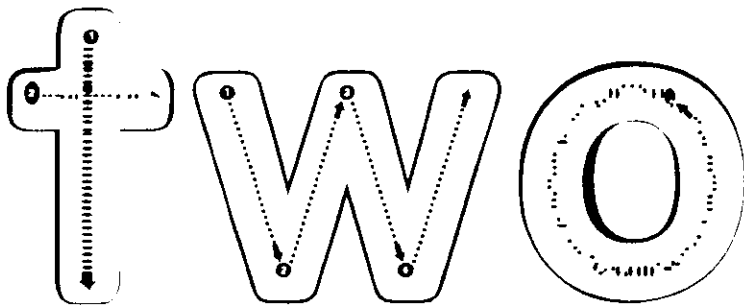
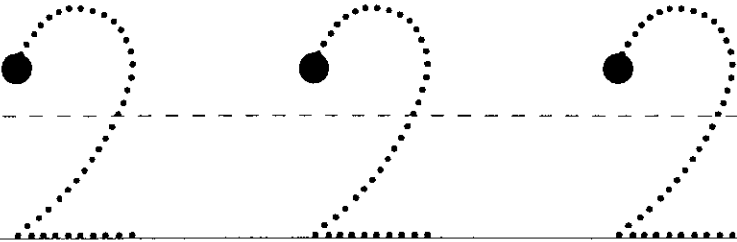
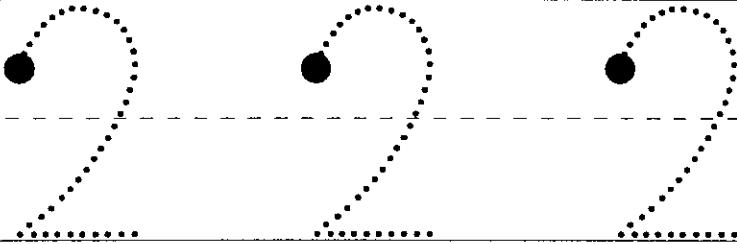

Color 2 pictures

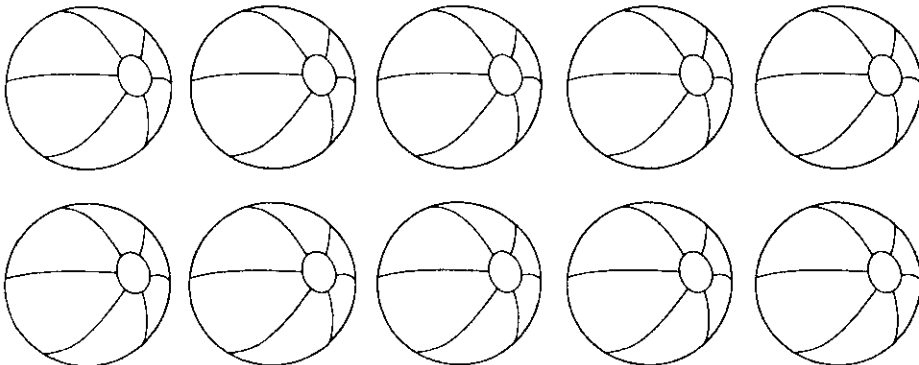

Find the number			
2	4	2	6
2	1	5	9
10	2	7	2
2	3	2	8

Name: _____

Number Review

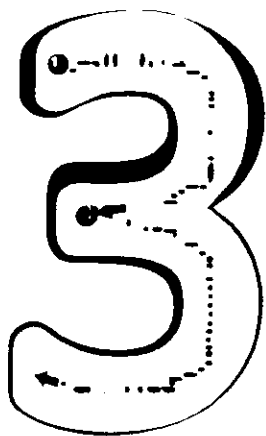

Trace & Write it

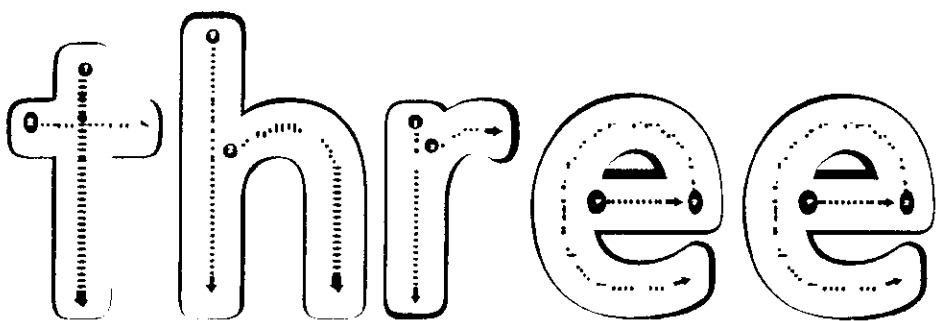
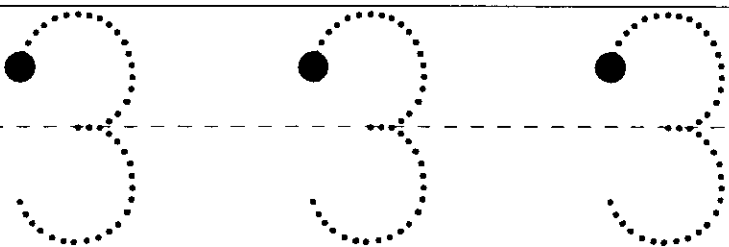
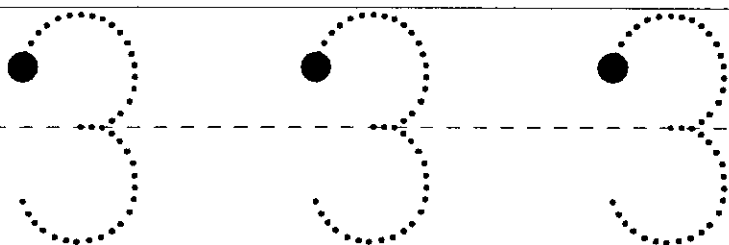

Color 3 pictures

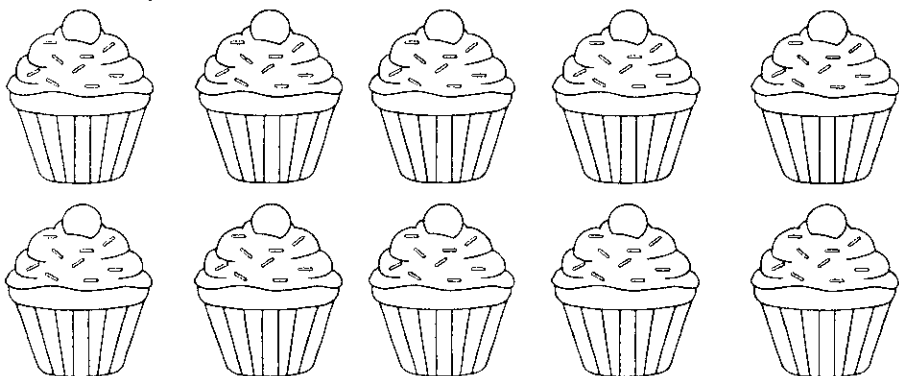

Find the number			
7	3	4	9
3	1	3	3
8	6	3	2
3	3	5	10

Name: _____

Number Review

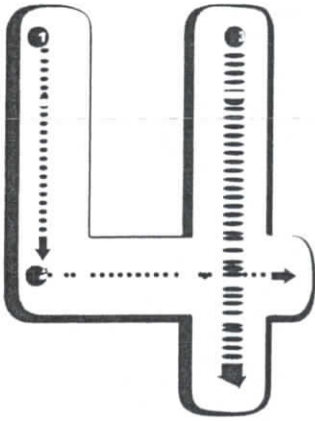

Trace & Write it

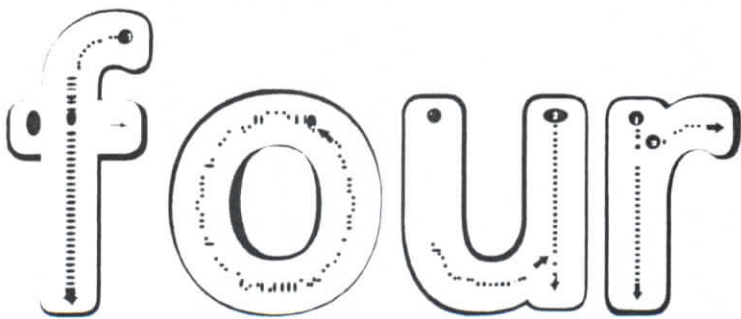
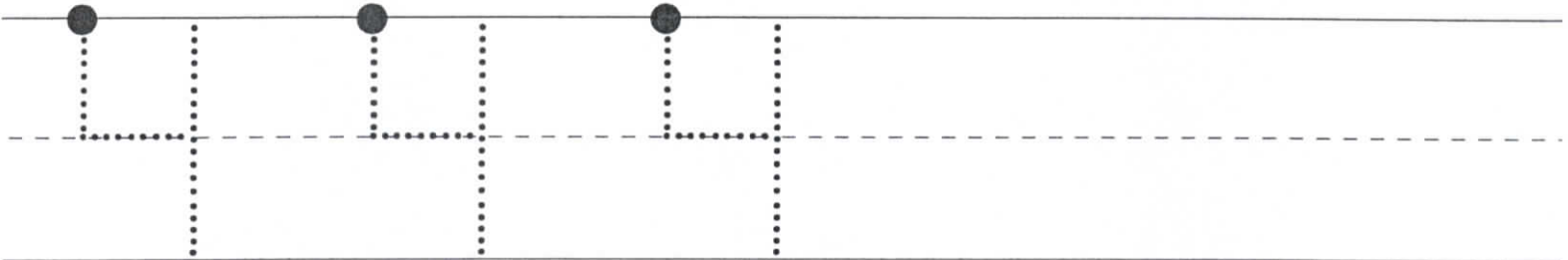
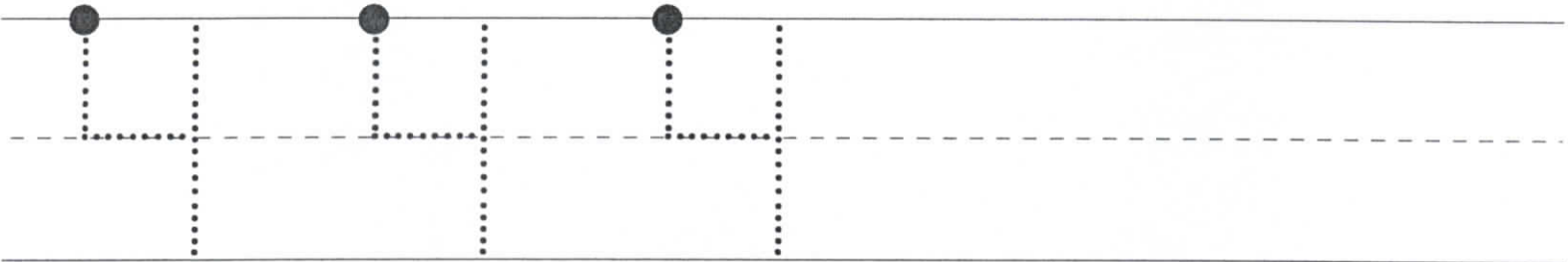

Color 4 pictures

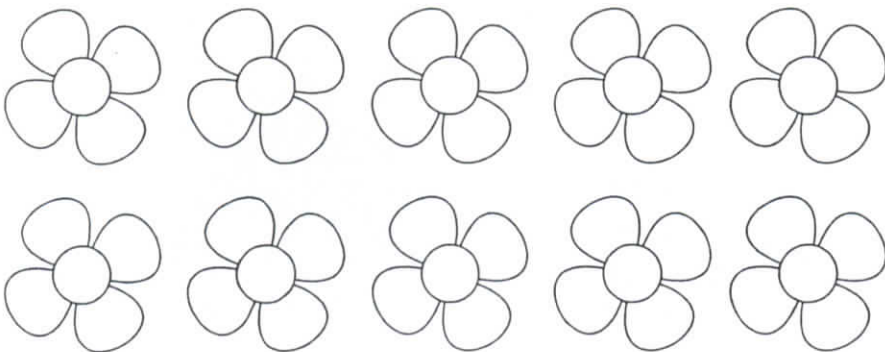

Find the number			
4	3	4	1
6	4	9	5
4	10	4	4
7	2	8	4

Name: _____

Number Review

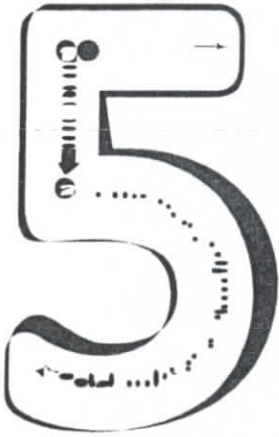

Trace & Write it

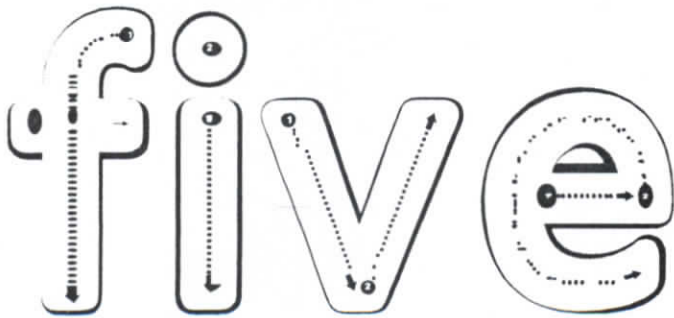
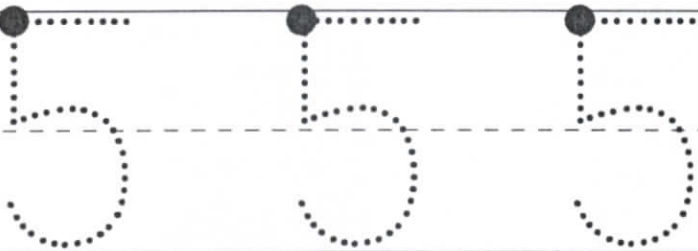
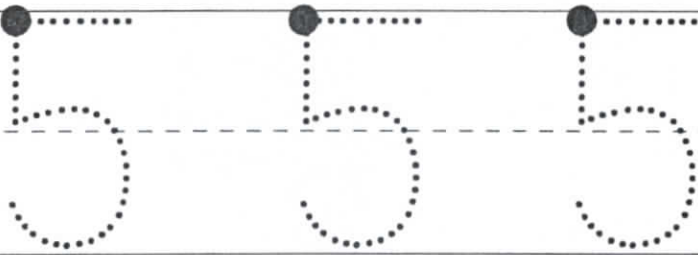

Color 5 pictures

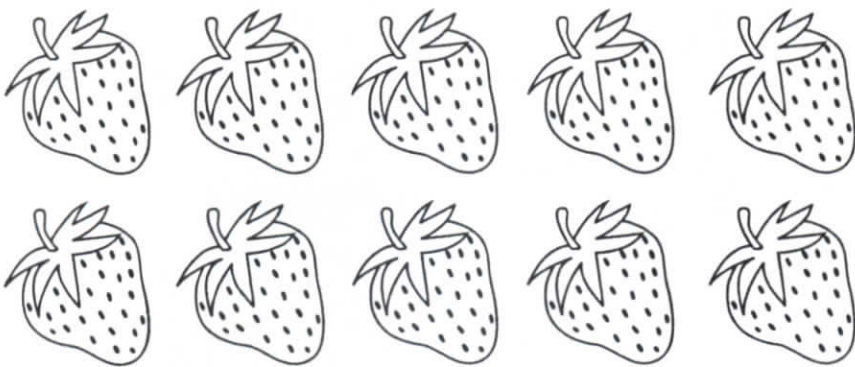

Find the number

1	5	7	3
5	6	9	5
4	5	2	8
5	10	5	5

Name: _____

Number Review



Trace & Write it

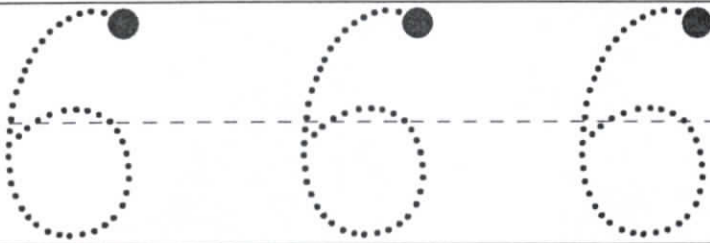
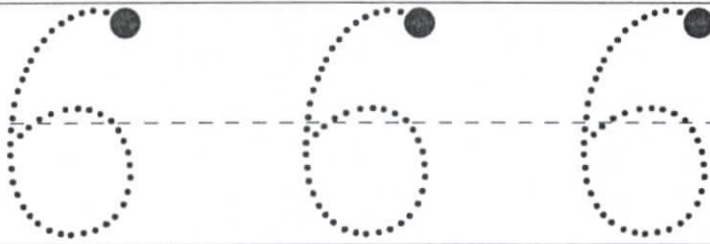

Color 6 pictures

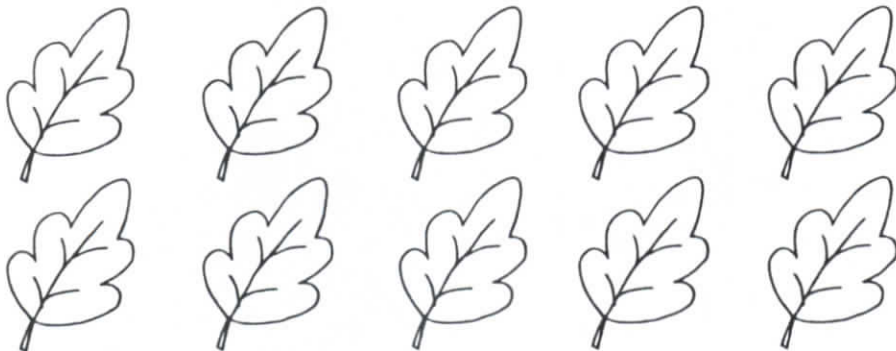

Find the number			
1	6	2	6
8	6	6	9
6	7	10	4
3	6	5	6

Name: _____

Number Review

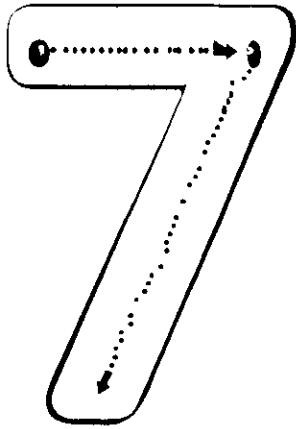

Trace & Write it

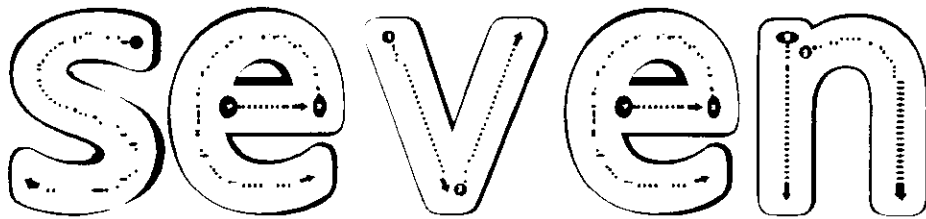
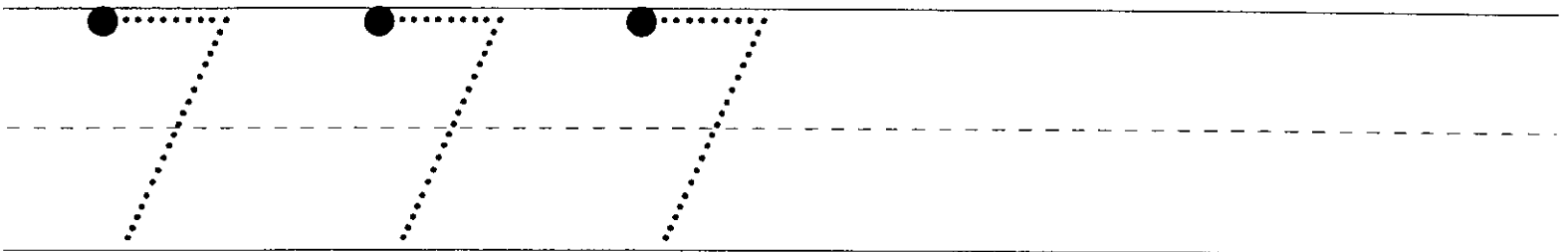
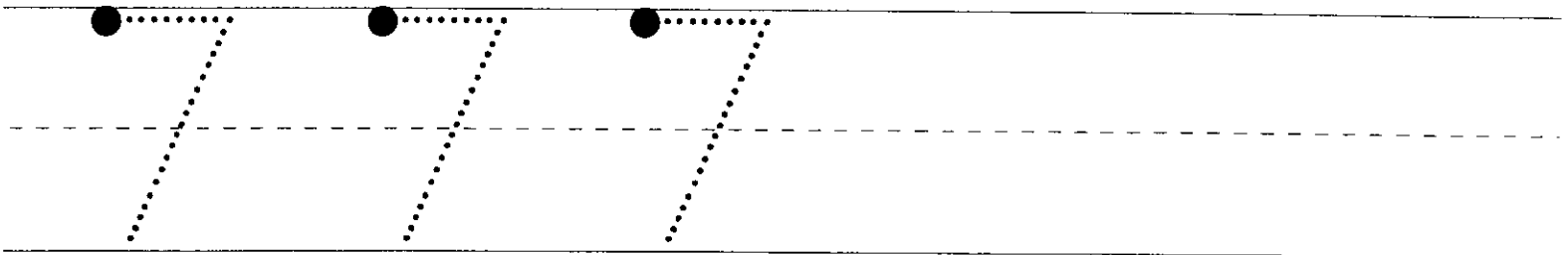

Color 7 pictures

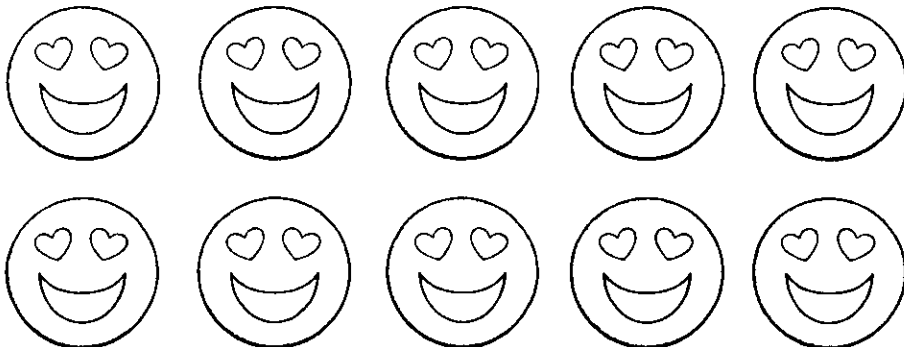

Find the number

7	6	2	7
7	4	7	9
1	7	10	5
3	8	7	7

Name: _____

Number Review

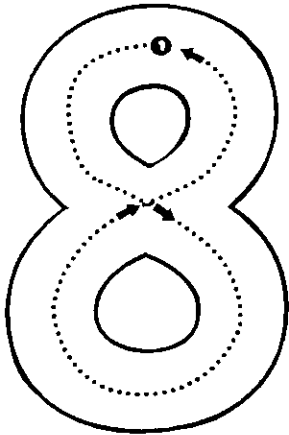

Trace & Write it

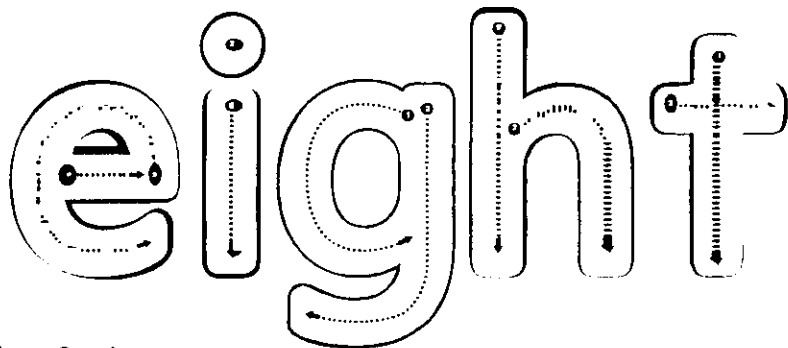
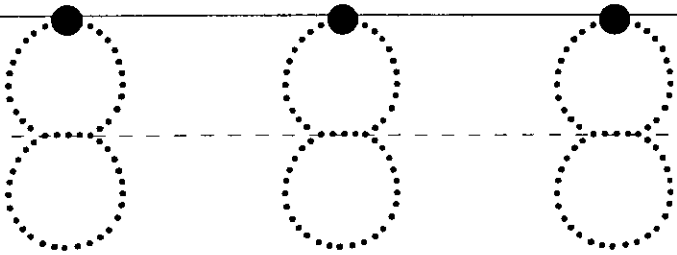
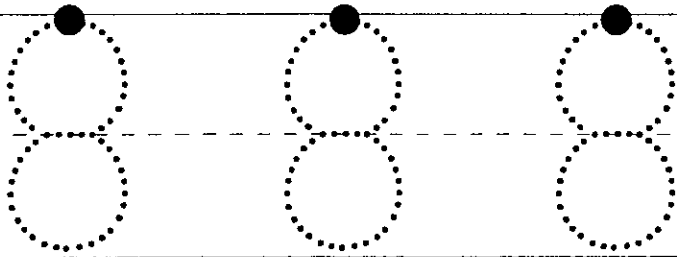

Color 8 pictures

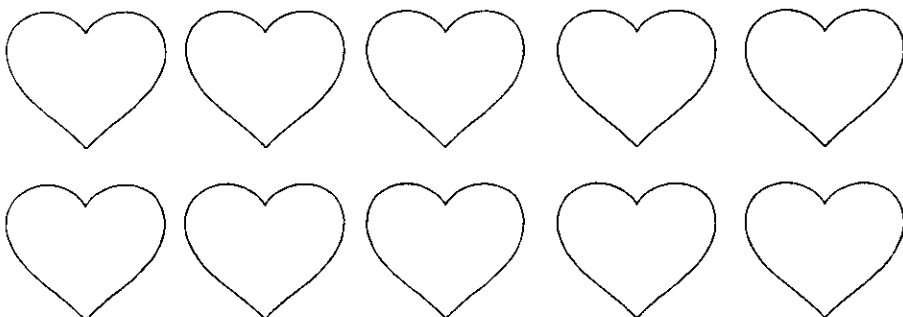

Find the number

3	6	8	2
8	4	8	9
1	8	10	8
7	8	8	5

Name: _____

Number Review

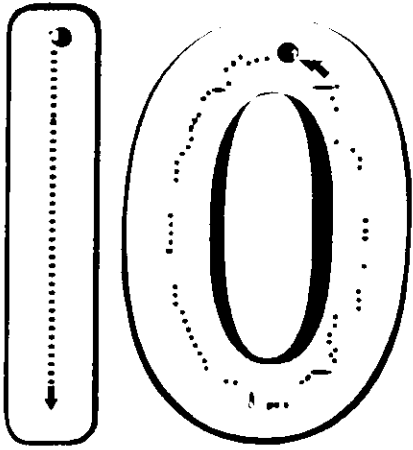

Trace & Write it

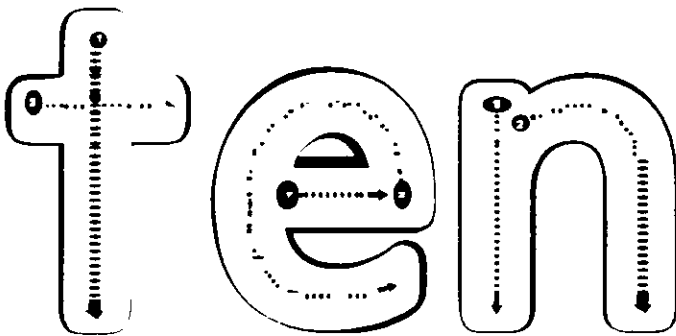
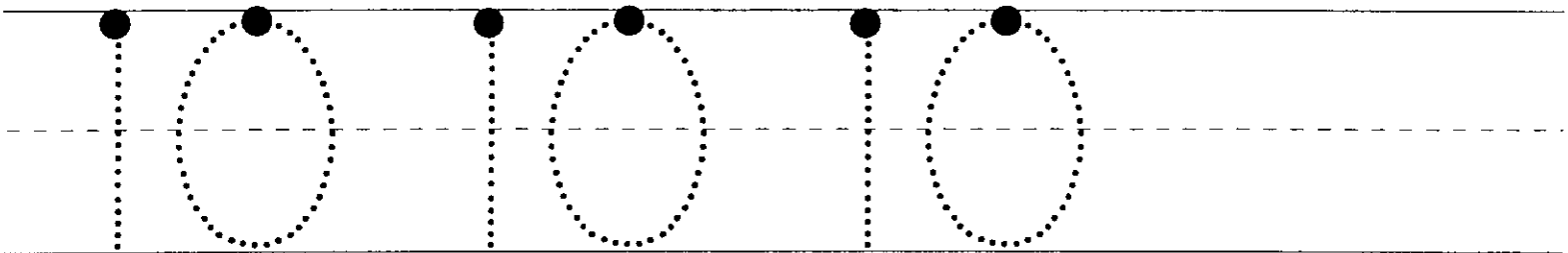
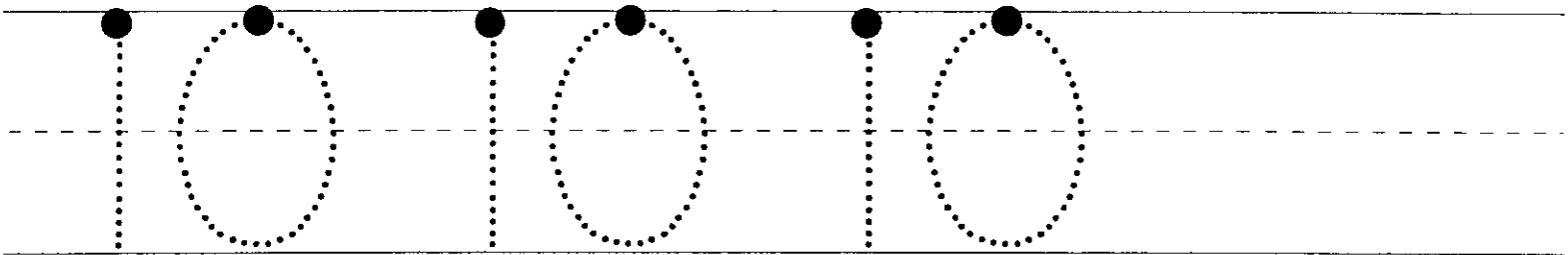

Color 10 pictures

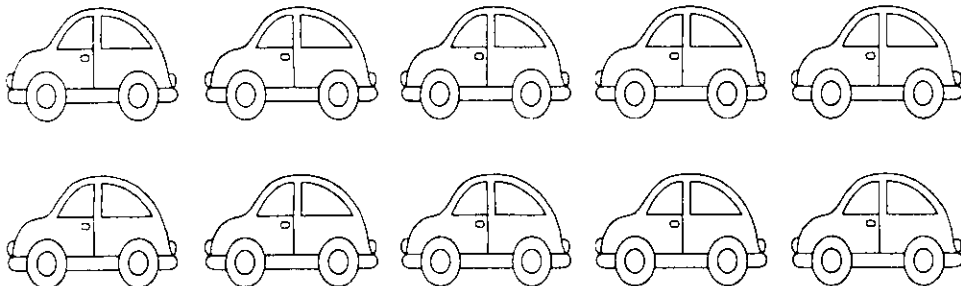

Find the number			
3	10	8	2
10	5	10	9
1	10	10	6
10	7	4	10